

図面番号 (DRAWING NO.) SJ114448

版数 VER.	年月日 DATE	CN NO.	変更内容 DESCRIPTION	製図 DR.	担当 CHK.	査閲 APPD.	承認 APPD.
2	10/JUL/2014	010321	REVISED FORM		T. URANO	H. KANNO	T. KUDOU

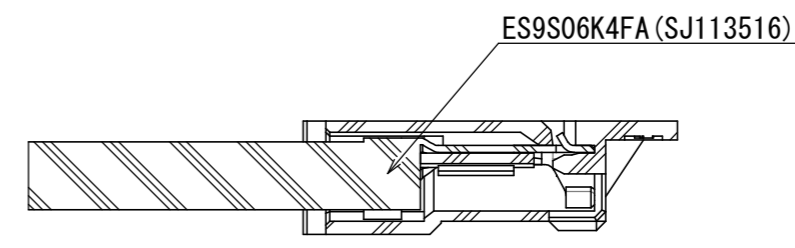

MATING CONDITON

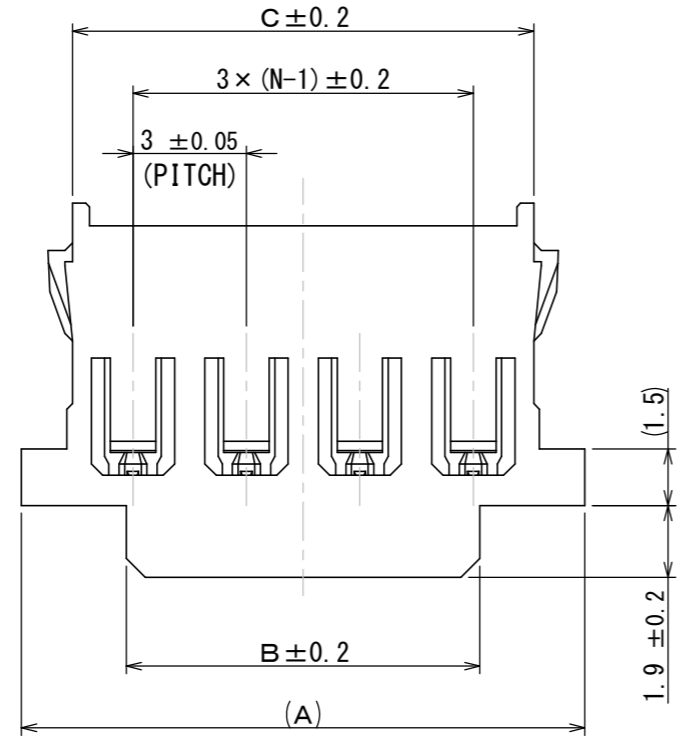
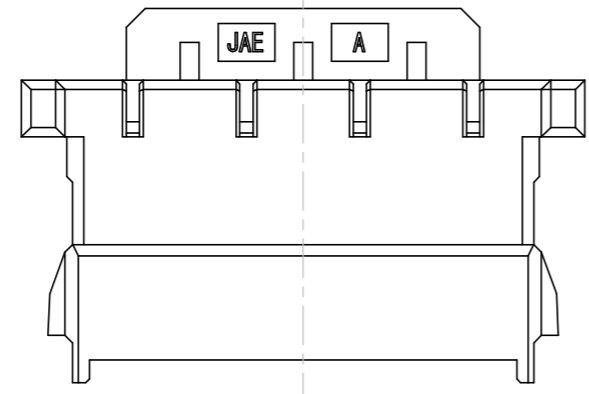
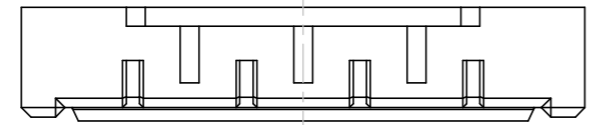
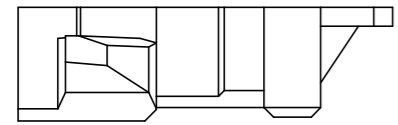
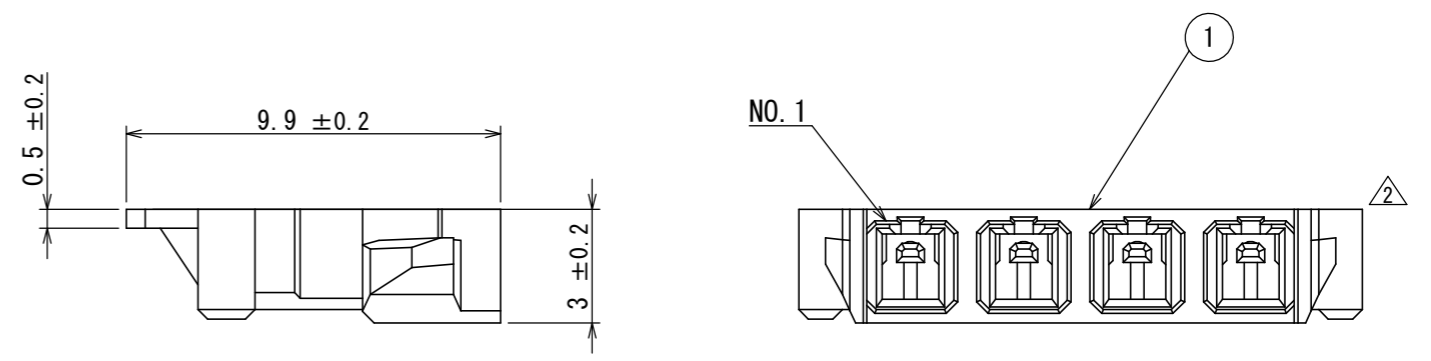
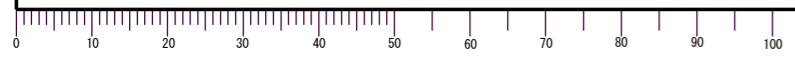

TABLE1

NO. OF CONTACTS	A	B	C
2	8.9	6.5	6.2
4	14.9	9.35	12.2

1	HOUSING	1	6-6Ny	COLOR: WHITE	
符号 NO.	名称 DESCRIPTION	個数 QTY.	材料 MATERIAL	仕上 FINISH	備考 REMARKS
仕様書 (SPECIFICATION) JACS-11001 JAHL-11001		第1版 (ORIGINAL DATE) 29/AUG/2013		尺度 (SCALE) 5:1	シリーズ (SERIES) ES9
一般公差 (GENERAL TOLERANCE)		製図 DR.	担当 CHK.	名称 (TITLE) ES9S00*SZZ	
寸法 (DIMENSION)		製図 DR.	担当 CHK.	HOUSING	
角度 (ANGLES)		製図 DR.	担当 CHK.	質量 (MASS)	
単位 (UNIT) : mm		製図 DR.	担当 CHK.	シリアル (SERIAL)	
		製図 DR.	担当 CHK.	日本航空電子工業株式会社	
		製図 DR.	担当 CHK.	JAE	
		製図 DR.	担当 CHK.	JAPAN AVIATION ELECTRONICS INDUSTRY, LTD.	
		製図 DR.	担当 CHK.	図面番号 (DRAWING NO.)	
		製図 DR.	担当 CHK.	SJ114448	
		製図 DR.	担当 CHK.	版数 (VER.)	
		製図 DR.	担当 CHK.	2	

DCF-C-212H(12.08)



WISDOM承認 2014/07/17