

APT130SM70J

700V, 78A, 35mΩ

Silicon Carbide N-Channel Power MOSFET

DESCRIPTION

Silicon carbide (SiC) power MOSFET product line from Microsemi increase your performance over silicon MOSFET and silicon IGBT solutions while lowering your total cost of ownership for high-voltage applications.

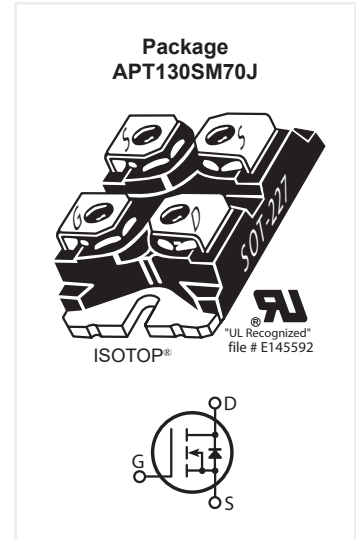

FEATURES / TYPICAL APPLICATIONS

SiC MOSFET Features:

- Low on-resistance virtually independent on the ambient temperature
- Low capacitances and low gate charge
- Fast switching speed due to low internal gate resistance (ESR)
- Stable operation at high junction temperature, $T_j(\text{max}) = +175\text{C}$
- Fast and reliable body diode
- Superior avalanche ruggedness

SiC MOSFET Benefits:

- High efficiency to enable lighter/compact system
- Simple to drive and easy to parallel
- Improved thermal capabilities and lower switching losses
- Eliminates the need of external Free Wheeling Diode
- Lower system cost of ownership

Applications:

- PV inverter, converter and industrial motor drives
- Smart grid transmission & distribution
- Induction heating, and welding
- H/EV powertrain and EV charger
- Power supply and distribution

MAXIMUM RATINGS

Symbol	Parameter	Ratings	Unit
V_{DSS}	Drain Source Voltage	700	V
I_D	Continuous Drain Current @ $T_c = 25^\circ\text{C}$	78	A
	Continuous Drain Current @ $T_c = 100^\circ\text{C}$	55	
I_{DM}	Pulsed Drain Current ^①	270	
V_{GS}	Gate-Source Voltage	-10 to +25	V
P_D	Total Power Dissipation @ $T_c = 25^\circ\text{C}$	273	W
	Linear Derating Factor	1.82	W/°C

THERMAL AND MECHANICAL CHARACTERISTICS

Symbol	Characteristic	Min	Typ	Max	Unit
$R_{\theta JC}$	Junction to Case Thermal Resistance		0.34	0.55	°C/W
T_j	Operating Junction Temperature	-55		175	°C
T_{stg}	Storage Junction Temperature Range	-55		150	
W_T	Package Weight			1.03	oz
Torque	Mounting Torque (SOT-227 Package), 6-32 or M3 screw		5	10	in·lbf
			.56	1.13	N·m

APT130SM70J

STATIC CHARACTERISTICS

Symbol	Parameter	Test Conditions	Min	Typ	Max	Unit
$V_{(BR)DSS}$	Drain-Source Breakdown Voltage	$V_{GS} = 0V, I_D = 1mA$	700			V
$R_{DS(on)}$	Drain-Source On Resistance ^②	$V_{GS} = 20V, I_D = 60A$		35	45	mΩ
$V_{GS(th)}$	Gate-Source Threshold Voltage	$V_{GS} = V_{DS}, I_D = 1mA$	1.7	2.4		V
$\Delta V_{GS(th)}/\Delta T_J$	Threshold Voltage Temperature Coefficient			-5.1		mV/°C
I_{DSS}	Zero Gate Voltage Drain Current	$V_{DS} = 700V$ $V_{GS} = 0V$		$T_J = 25^\circ C$	100	μA
				$T_J = 150^\circ C$	250	
I_{GSS}	Gate-Source Leakage Current	$V_{GS} = +20V / -10V$			±100	nA
ESR	Equivalent Series Resistance	$f = 1MHz, 25mV, \text{Drain Short}$		0.46		Ω

$T_J = 25^\circ C$ unless otherwise specified

DYNAMIC CHARACTERISTICS

Symbol	Parameter	Test Conditions	Min	Typ	Max	Unit
C_{iss}	Input Capacitance	$V_{GS} = 0V, V_{DD} = 700V$ $f = 1MHz$		3950		pF
C_{riss}	Reverse Transfer Capacitance			50		
C_{oss}	Output Capacitance			465		
Q_g	Total Gate Charge	$V_{GS} = 0/20V$		270		nC
Q_{gs}	Gate-Source Charge	$V_{DD} = 466V$		42		
Q_{gd}	Gate-Drain Charge	$I_D = 60A$		61		
$t_{d(on)}$	Turn-On Delay Time	$V_{DD} = 466V$ $V_{GS} = 0/20V$ $I_D = 60A$ $R_G = 1.5 \Omega$ ^③ $L = 115 \mu H$ $T_c = 25^\circ C$ Freewheeling Diode = APT20SCE65B		17		ns
t_r	Current Rise Time			15		
$t_{d(off)}$	Turn-Off Delay Time			36		
t_f	Current Fall Time			19		
E_{on2}	Turn-On Switching Energy ^④	$V_{DD} = 466V$ $V_{GS} = 0/20V$ $I_D = 60A$ $R_G = 1.5 \Omega$ ^③ $L = 115 \mu H$ $T_c = 150^\circ C$ Freewheeling Diode = APT20SCE65B		1060		μJ
E_{off}	Turn-Off Switching Energy			305		
$t_{d(on)}$	Turn-On Delay Time			16		ns
t_r	Current Rise Time			15		
$t_{d(off)}$	Turn-Off Delay Time			39		
t_f	Current Fall Time			21		
E_{on2}	Turn-On Switching Energy ^④			965		μJ
E_{off}	Turn-Off Switching Energy			345		

Source-Drain Diode Characteristics

Symbol	Parameter	Test Conditions	Min	Typ	Max	Unit
V_{SD}	Diode Forward Voltage	$I_{SD} = 60A, V_{GS} = 0V$		3.85		V
t_{rr}	Reverse Recovery Time	$I_{SD} = 60A, V_{DD} = 466V$ $di/dt = -1000A/\mu s$		68		ns
Q_{rr}	Reverse Recovery Charge			460		nC
I_{rrm}	Reverse Recovery Current			15		A

$T_J = 25^\circ C$ unless otherwise specified

① Repetitive Rating: Pulse width and case temperature limited by maximum junction temperature

② Pulse test: Pulse Width < 380μs, duty cycle < 2%.

③ R_G is total gate resistance including internal gate driver impedance.

④ E_{on2} includes energy of APT20SCE65B free wheeling diode.

APT130SM70J

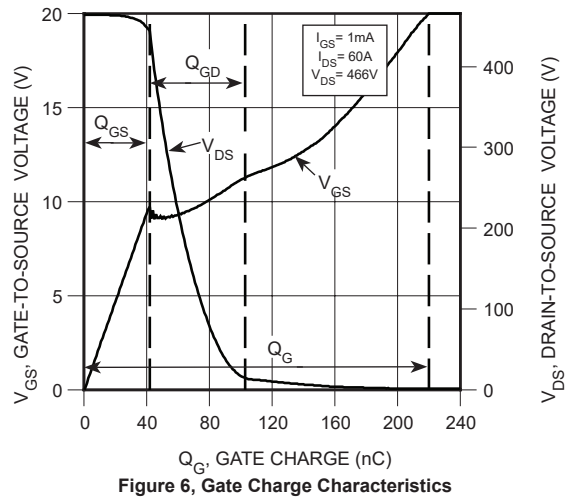
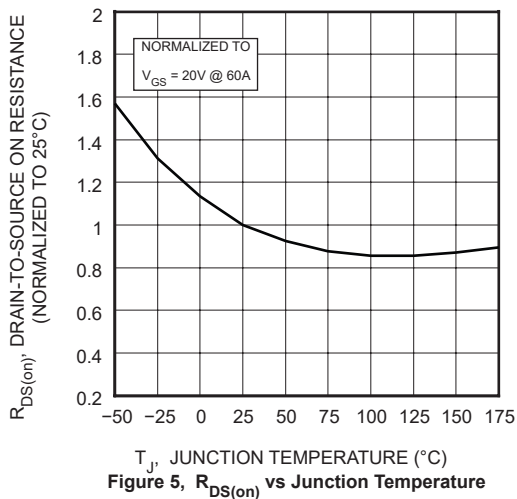
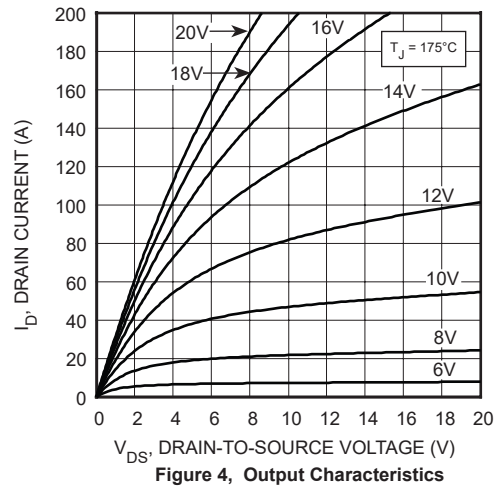
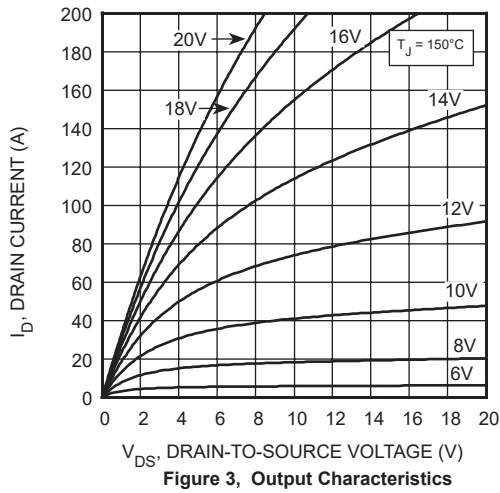
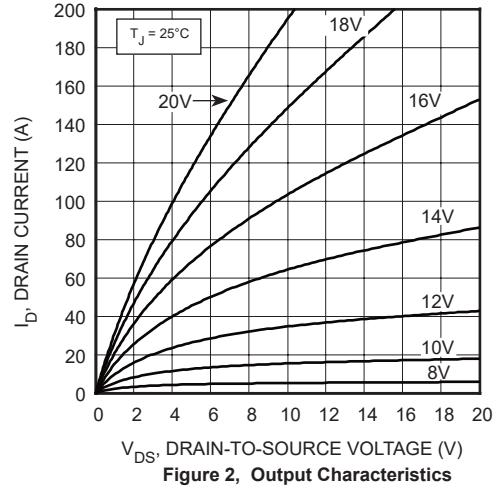
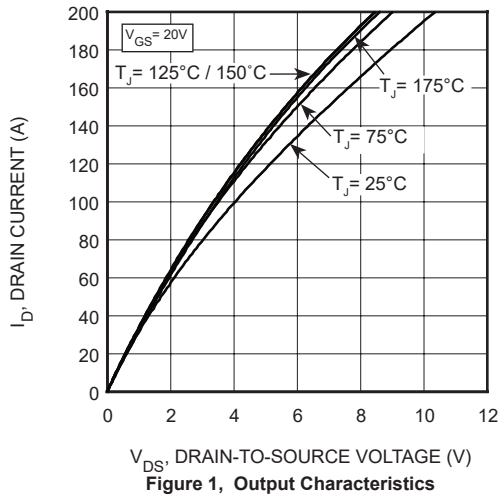

APT130SM70J

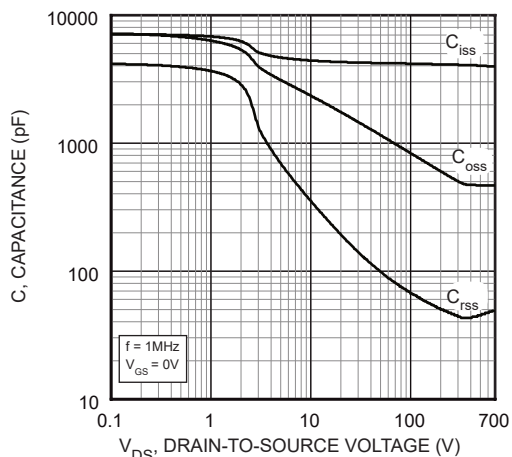

Figure 7, Capacitance vs Drain-to-Source Voltage

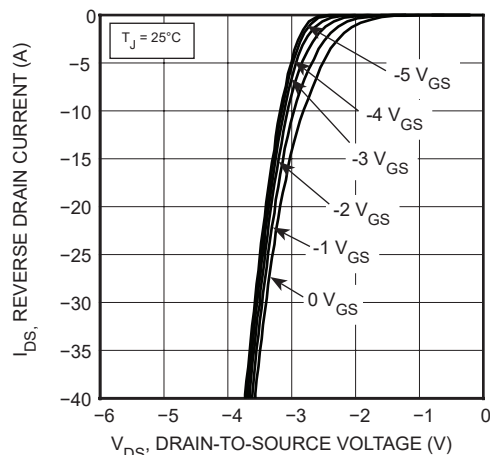

Figure 8, Reverse Drain Current vs Drain-to-Source Voltage
Third Quadrant Conduction

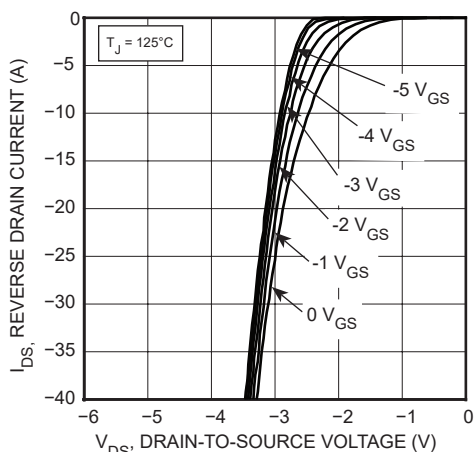

Figure 9, Reverse Drain Current vs Drain-to-Source Voltage
Third Quadrant Conduction

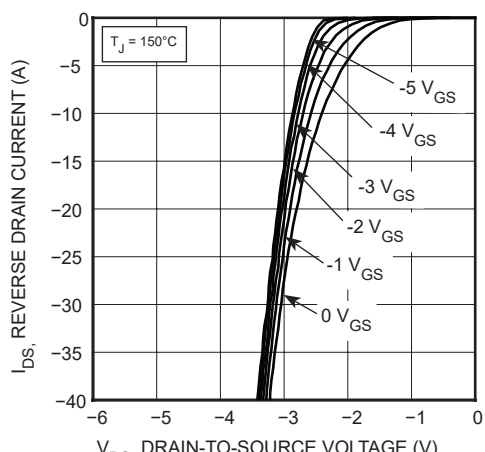

Figure 10, Reverse Drain Current vs Drain-to-Source Voltage
Third Quadrant Conduction

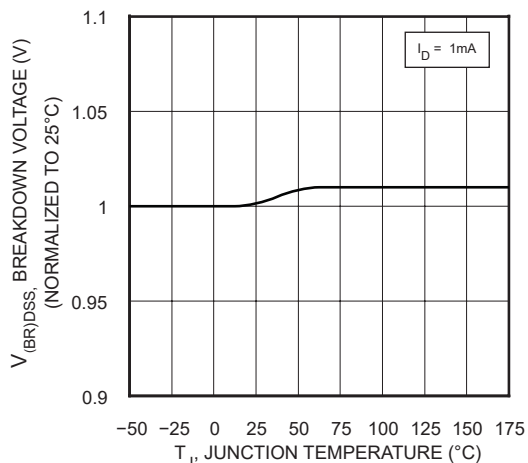

Figure 11, Breakdown Voltage vs Temperature

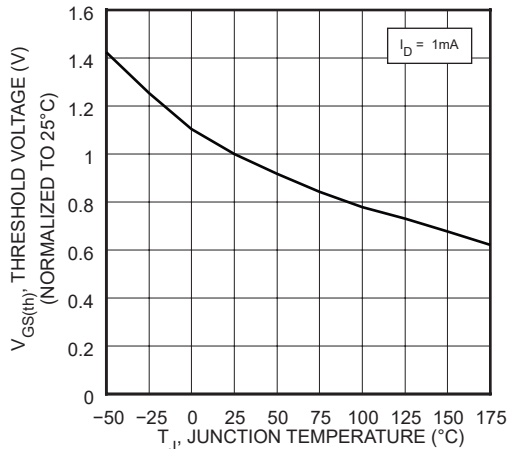

Figure 12, Threshold Voltage vs Temperature

APT130SM70J

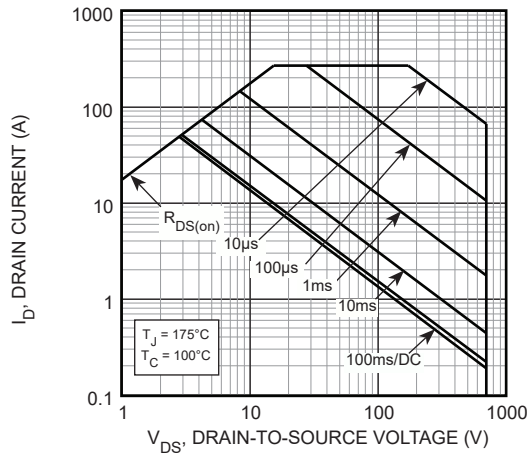

Figure 13, Forward Safe Operating Area

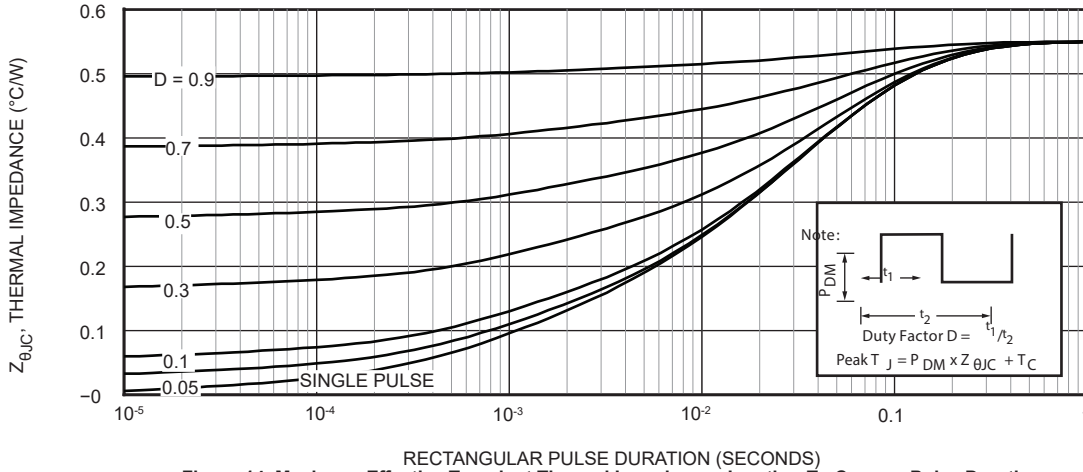
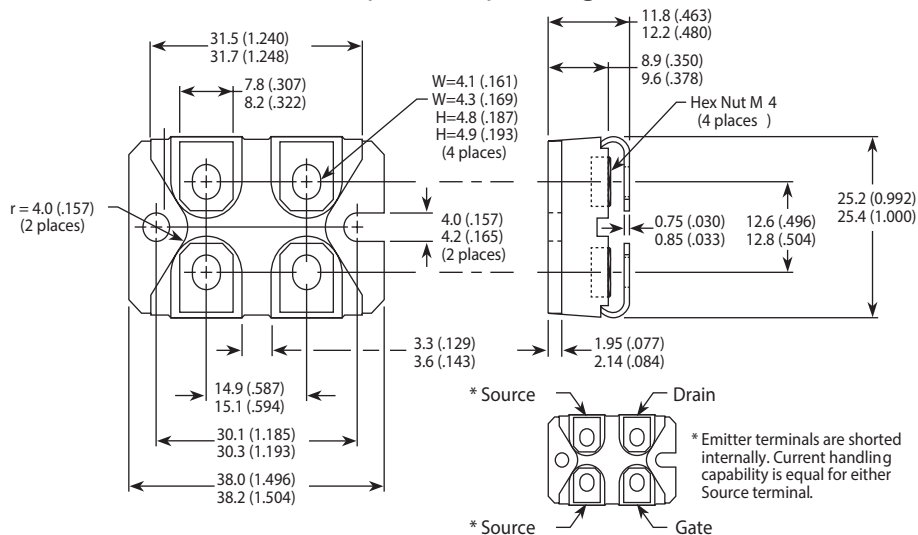

Figure 14, Maximum Effective Transient Thermal Impedance, Junction-To-Case vs Pulse Duration

SOT-227 (ISOTOP®) Package Outline



Dimensions in Millimeters (Inches)

Microsemi makes no warranty, representation, or guarantee regarding the information contained herein or the suitability of its products and services for any particular purpose, nor does Microsemi assume any liability whatsoever arising out of the application or use of any product or circuit. The products sold hereunder and any other products sold by Microsemi have been subject to limited testing and should not be used in conjunction with mission-critical equipment or applications. Any performance specifications are believed to be reliable but are not verified, and Buyer must conduct and complete all performance and other testing of the products, alone and together with, or installed in, any end-products. Buyer shall not rely on any data and performance specifications or parameters provided by Microsemi. It is the Buyer's responsibility to independently determine suitability of any products and to test and verify the same. The information provided by Microsemi hereunder is provided "as is, where is" and with all faults, and the entire risk associated with such information is entirely with the Buyer. Microsemi does not grant, explicitly or implicitly, to any party any patent rights, licenses, or any other IP rights, whether with regard to such information itself or anything described by such information. Information provided in this document is proprietary to Microsemi, and Microsemi reserves the right to make any changes to the information in this document or to any products and services at any time without notice.



Microsemi Corporate Headquarters
One Enterprise, Aliso Viejo, CA 92656 USA
Within the USA: +1 (800) 713-4113
Outside the USA: +1 (949) 380-6100
Sales: +1 (949) 380-6136
Fax: +1 (949) 215-4996
email: sales.support@microsemi.com
www.microsemi.com

Microsemi Corporation (Nasdaq: MSCC) offers a comprehensive portfolio of semiconductor and system solutions for communications, defense & security, aerospace and industrial markets. Products include high-performance and radiation-hardened analog mixed-signal integrated circuits, FPGAs, SoCs and ASICs; power management products; timing and synchronization devices and precise time solutions, setting the world's standard for time; voice processing devices; RF solutions; discrete components; security technologies and scalable anti-tamper products; Ethernet Solutions; Power-over-Ethernet ICs and midspans; as well as custom design capabilities and services. Microsemi is headquartered in Aliso Viejo, Calif., and has approximately 4,800 employees globally. Learn more at www.microsemi.com.

©2016 Microsemi Corporation. All rights reserved. Microsemi and the Microsemi logo are registered trademarks of Microsemi Corporation. All other trademarks and service marks are the property of their respective owners.