

Wide band directional coupler with ISO port

Datasheet - production data

Features

- 50 Ω nominal input / output impedance
- Wide operating frequency range (698 MHz to 2700 MHz)
- Low insertion loss
- 30 dB coupling factor with high flatness
- High directivity
- High ESD robustness (IEC 61000-4-2 level 4)
- Flip Chip package
- Small footprint

Benefits

- Very low profile (< 560 μm thickness after reflow)
- Lead-free package
- High RF performance
- RF module size reduction
- 50 Ω nominal input / output impedance
- Fully symmetrical design

Applications

- Quad-band power amplifier module
- Quad-band front end module
- GSM / WCDMA / LTE mobile phone

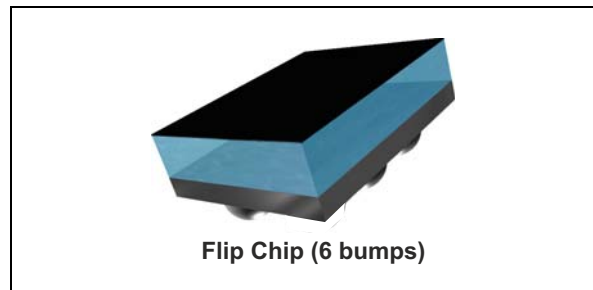
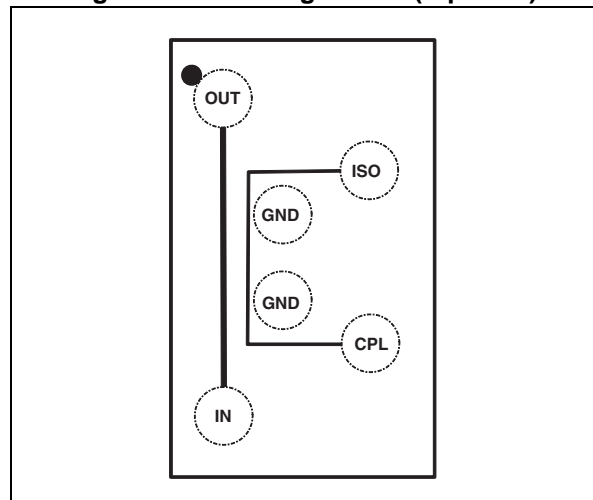

Figure 1. Pin configuration (top view)



Description

The CPL-WBF-00D3 is a wide-band directional coupler designed to measure RF antenna output power in GSM / WCDMA / TD-SCDMA / LTE applications. This coupler has been customized for wide band operating frequencies (EGSM, CELL, PCS, DCS, TD-SCDMA, WCDMA and LTE) with less than 0.30 dB insertion losses in the bandwidth (698 MHz to 2700 MHz).

The CPL-WBF-00D3 has been designed using STMicroelectronics IPD (integrated passive device) technology on non-conductive glass substrate to optimize RF performance. The device is delivered 100% tested in tape and reel.

1 Characteristics

Table 1. Absolute maximum rating (limiting values)

Symbol	Parameter	Frequency band	Test condition	Value			Unit
				Min.	Typ.	Max.	
P _{IN}	Input power RF _{IN}	CW	698-880			30	dBm
		DC 50% CW	880-915			35 30	
		CW	1428-1661			30	
		DC 50% CW	1710-1910			33 30	
		CW	1920-2170			27	
		CW	1920-2025			30	
		CW	2500-2700			30	
V _{ESD}	ESD ratings IEC61000-4-2 (C = 150 pF, R = 330 Ω, 10 shots with both polarities and each condition, cumulative method) RF _{IN} , RF _{OUT} , air discharge RF _{IN} , RF _{OUT} , contact discharge			±15 ±8			kV kV
V _{ESD} (HBM)	Human body model, JESD22-A114-B, All I/O			2			kV
V _{ESD} (MM)	Machine model, JESD22-A115-A, All I/O			100			V
V _{ESD} (CDM)	Charge device model, JESD22-C101-C, All I/O			500			V
T _{OP}	Operating temperature			-30		+85	°C

Table 2. Electrical characteristics (T_{amb} = 25 °C) - impedances

Symbol	Parameter	Value			Unit
		Min.	Typ.	Max.	
Z _{OUT}	Nominal output impedance		50		Ω
Z _{IN}	Nominal input impedance		50		Ω
Z _{CPLD}	Nominal coupling impedance		50		Ω
Z _{ISO}	Nominal isolated port impedance		50		Ω

Table 3. Electrical characteristics (T_{amb} = 25 °C) - RF performance

Symbol	Parameter	Test condition	Value			Unit
			Min.	Typ.	Max.	
F	Frequency range (bandwidth)		698		2700	MHz
I _L	Insertion loss in bandwidth	From 698 MHz to 2700 MHz		0.15	0.3	dB
R _L	Return loss in bandwidth		15			dB
CPLD	Coupling factor		29		33	dB
DIR	Coupler directivity		20			dB

1.1 RF measurements

Figure 2. Insertion loss



Figure 3. Coupling factor

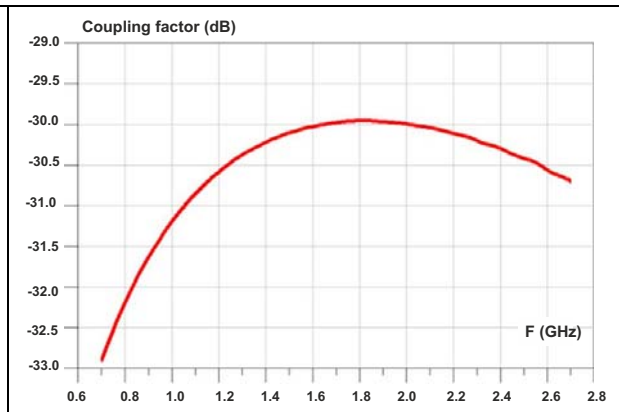

Figure 4. Directivity

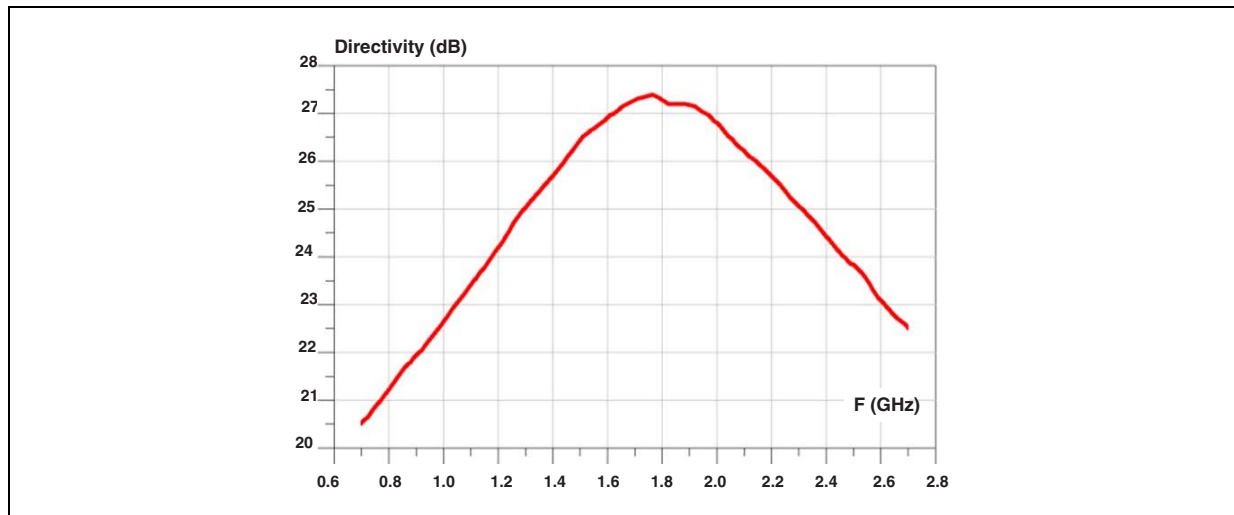

Figure 5. RL IN

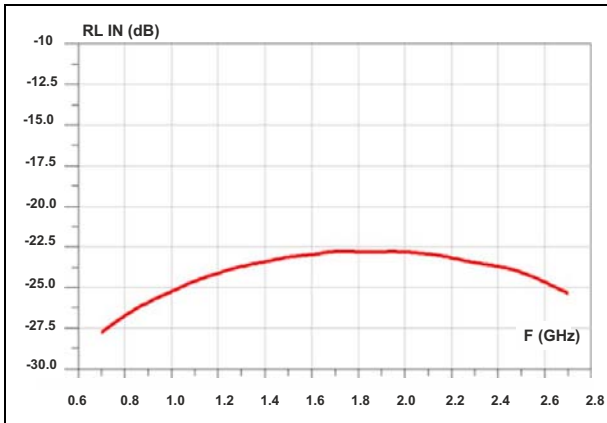

Figure 6. RL OUT

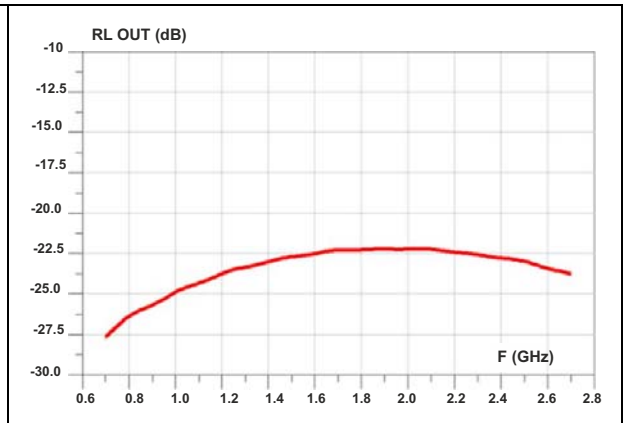

Figure 7. RL CPL

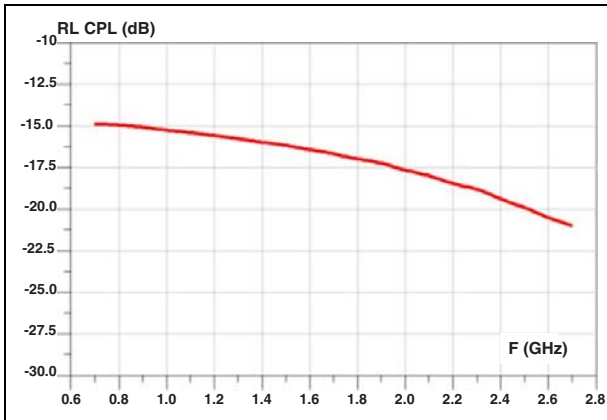
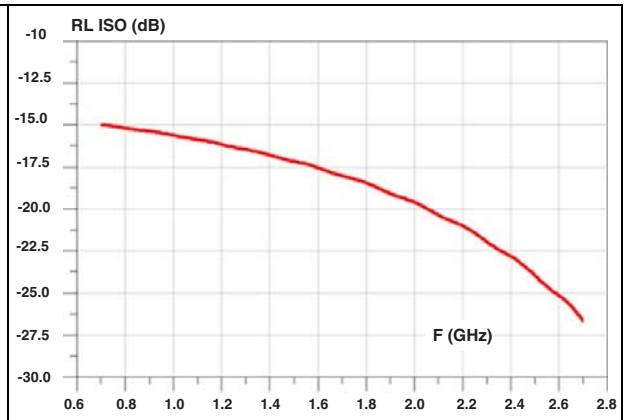

Figure 8. RL ISO



2 Package information

- Epoxy meets UL94, V0
- Lead-free package

In order to meet environmental requirements, ST offers these devices in different grades of ECOPACK® packages, depending on their level of environmental compliance. ECOPACK® specifications, grade definitions and product status are available at: www.st.com. ECOPACK® is an ST trademark.

Figure 9. Package dimensions

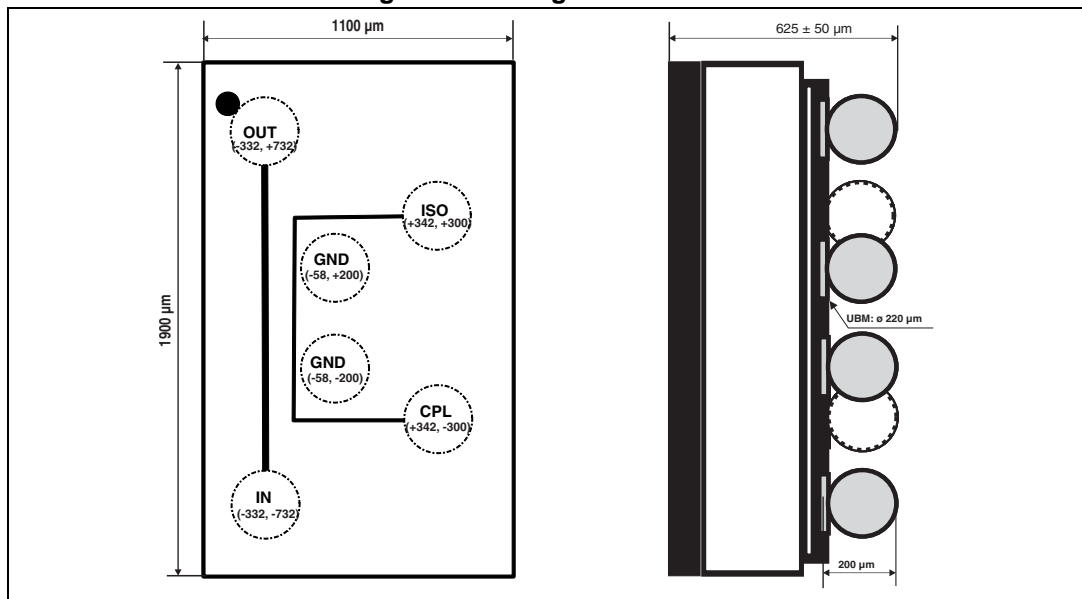

Figure 10. Footprint - non solder mask defined

Figure 11. Footprint - solder mask defined

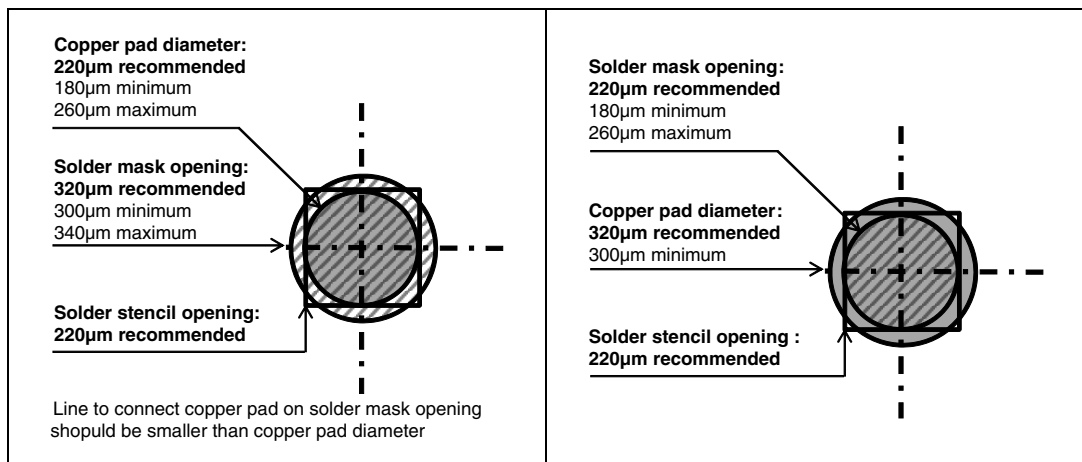

Figure 12. Marking

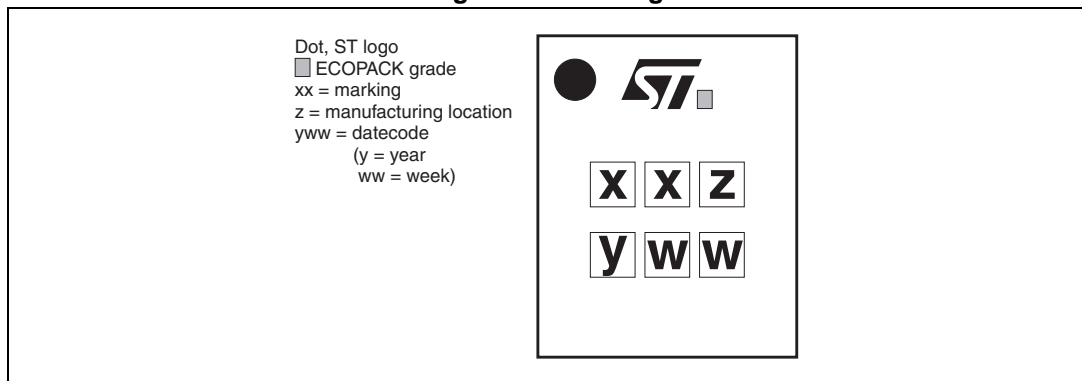

Figure 13. Land pattern recommendations

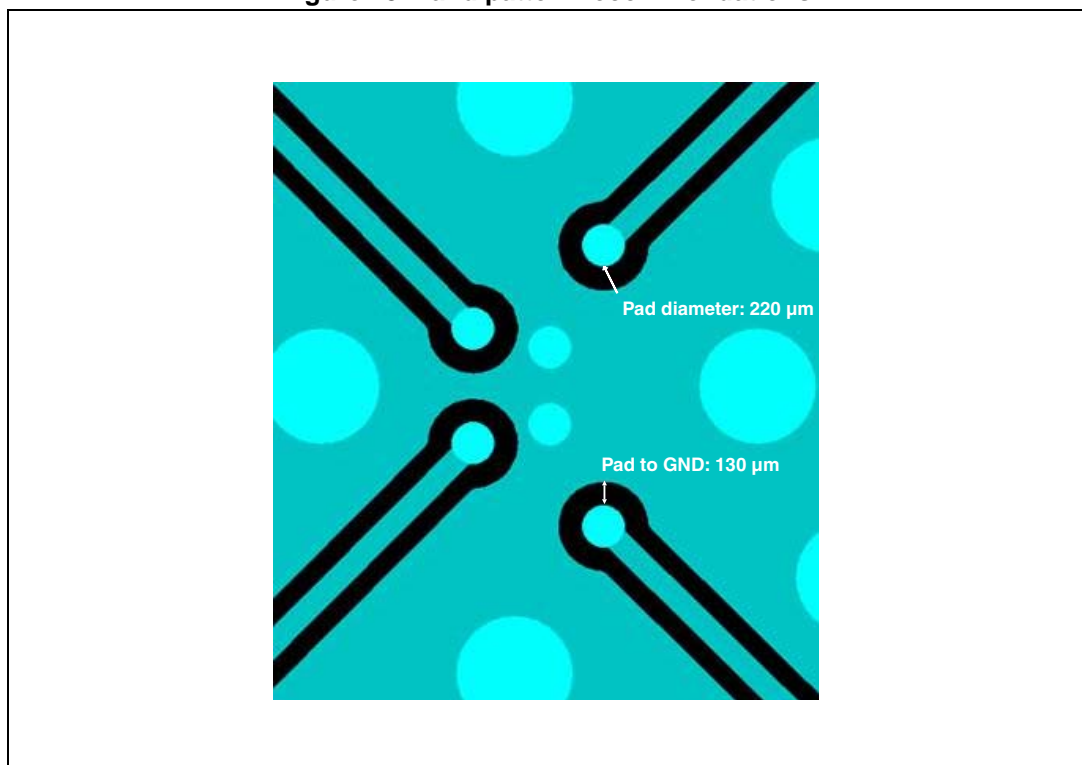
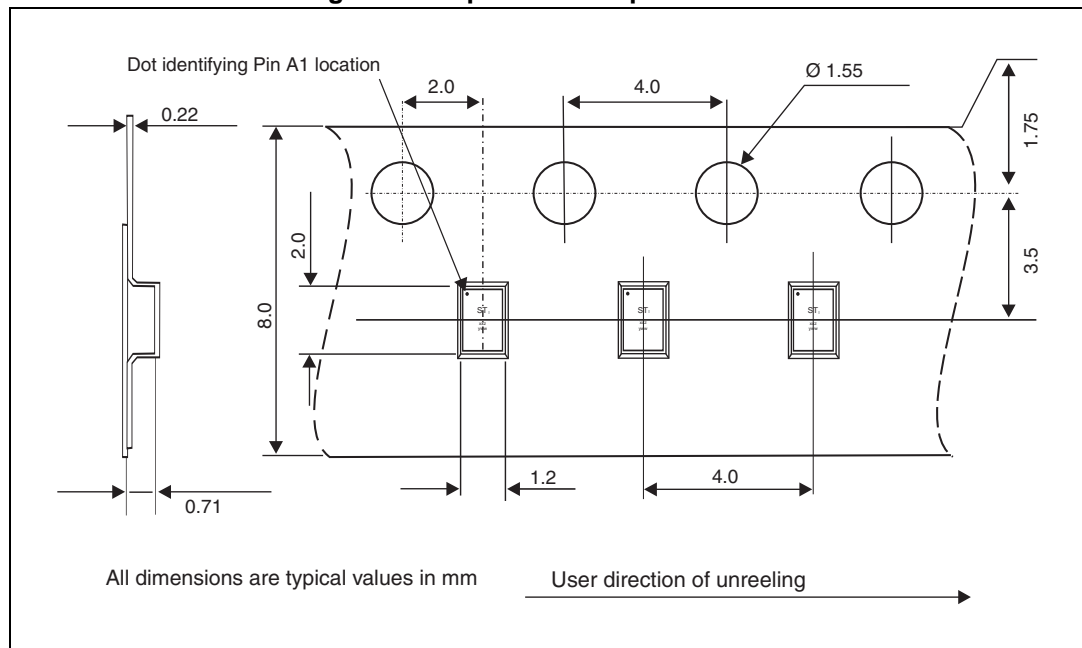

Figure 14. Tape and reel specifications



Note: More information is available in the STMicroelectronics Application note:
AN2348: "IPAD™ 400 µm Flip Chip: package description and recommendations for use"

3 Ordering information

Table 4. Ordering information

Order code	Marking	Package	Weight	Base qty	Delivery mode
CPL-WBF-00D3	SD	Flip Chip	2.35 mg	5000	Tape and reel (7")

4 Revision history

Table 5. Document revision history

Date	Revision	Changes
09-Jan-2013	1	Initial release
09-Aug-2013	2	Updated footprint graphics.

Please Read Carefully:

Information in this document is provided solely in connection with ST products. STMicroelectronics NV and its subsidiaries ("ST") reserve the right to make changes, corrections, modifications or improvements, to this document, and the products and services described herein at any time, without notice.

All ST products are sold pursuant to ST's terms and conditions of sale.

Purchasers are solely responsible for the choice, selection and use of the ST products and services described herein, and ST assumes no liability whatsoever relating to the choice, selection or use of the ST products and services described herein.

No license, express or implied, by estoppel or otherwise, to any intellectual property rights is granted under this document. If any part of this document refers to any third party products or services it shall not be deemed a license grant by ST for the use of such third party products or services, or any intellectual property contained therein or considered as a warranty covering the use in any manner whatsoever of such third party products or services or any intellectual property contained therein.

UNLESS OTHERWISE SET FORTH IN ST'S TERMS AND CONDITIONS OF SALE ST DISCLAIMS ANY EXPRESS OR IMPLIED WARRANTY WITH RESPECT TO THE USE AND/OR SALE OF ST PRODUCTS INCLUDING WITHOUT LIMITATION IMPLIED WARRANTIES OF MERCHANTABILITY, FITNESS FOR A PARTICULAR PURPOSE (AND THEIR EQUIVALENTS UNDER THE LAWS OF ANY JURISDICTION), OR INFRINGEMENT OF ANY PATENT, COPYRIGHT OR OTHER INTELLECTUAL PROPERTY RIGHT.

ST PRODUCTS ARE NOT AUTHORIZED FOR USE IN WEAPONS. NOR ARE ST PRODUCTS DESIGNED OR AUTHORIZED FOR USE IN: (A) SAFETY CRITICAL APPLICATIONS SUCH AS LIFE SUPPORTING, ACTIVE IMPLANTED DEVICES OR SYSTEMS WITH PRODUCT FUNCTIONAL SAFETY REQUIREMENTS; (B) AERONAUTIC APPLICATIONS; (C) AUTOMOTIVE APPLICATIONS OR ENVIRONMENTS, AND/OR (D) AEROSPACE APPLICATIONS OR ENVIRONMENTS. WHERE ST PRODUCTS ARE NOT DESIGNED FOR SUCH USE, THE PURCHASER SHALL USE PRODUCTS AT PURCHASER'S SOLE RISK, EVEN IF ST HAS BEEN INFORMED IN WRITING OF SUCH USAGE, UNLESS A PRODUCT IS EXPRESSLY DESIGNATED BY ST AS BEING INTENDED FOR "AUTOMOTIVE, AUTOMOTIVE SAFETY OR MEDICAL" INDUSTRY DOMAINS ACCORDING TO ST PRODUCT DESIGN SPECIFICATIONS. PRODUCTS FORMALLY ESCC, QML OR JAN QUALIFIED ARE DEEMED SUITABLE FOR USE IN AEROSPACE BY THE CORRESPONDING GOVERNMENTAL AGENCY.

Resale of ST products with provisions different from the statements and/or technical features set forth in this document shall immediately void any warranty granted by ST for the ST product or service described herein and shall not create or extend in any manner whatsoever, any liability of ST.

ST and the ST logo are trademarks or registered trademarks of ST in various countries.

Information in this document supersedes and replaces all information previously supplied.

The ST logo is a registered trademark of STMicroelectronics. All other names are the property of their respective owners.

© 2013 STMicroelectronics - All rights reserved

STMicroelectronics group of companies

Australia - Belgium - Brazil - Canada - China - Czech Republic - Finland - France - Germany - Hong Kong - India - Israel - Italy - Japan - Malaysia - Malta - Morocco - Philippines - Singapore - Spain - Sweden - Switzerland - United Kingdom - United States of America

www.st.com

