

Features

- Ideal for indication light on hand held products
- Long life and robust package
- Standard Package: 2,000pcs/ Reel
- MSL (Moisture Sensitivity Level): 3
- RoHS compliant



ATTENTION
OBSERVE PRECAUTIONS
FOR HANDLING
ELECTROSTATIC
DISCHARGE
SENSITIVE
DEVICES

Package Schematics

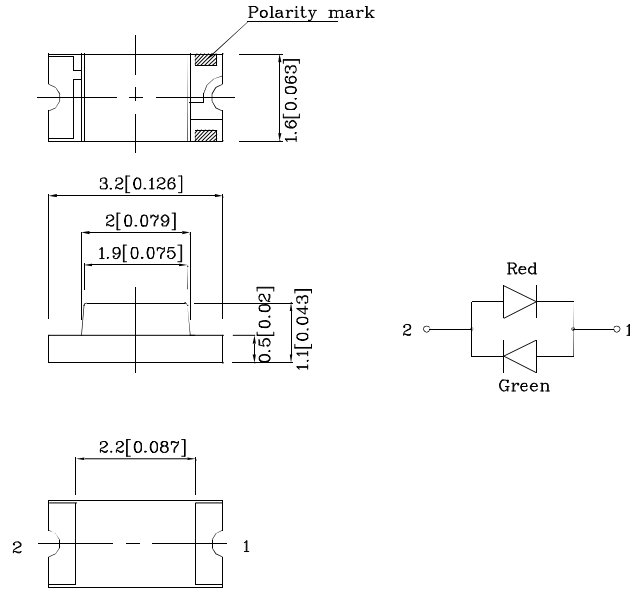

Notes:

1. All dimensions are in millimeters (inches).
2. Tolerance is $\pm 0.2(0.008")$ unless otherwise noted.
3. Specifications are subject to change without notice.

Absolute Maximum Ratings (T _A =25°C)		Red (AlGaInP)	Green (AlGaInP)	Unit
Forward Current	I _F	30	30	mA
Forward Current (Peak) 1/10 Duty Cycle 0.1ms Pulse Width	i _{FS}	185	150	mA
Power Dissipation	P _D	75	75	mW
Operating Temperature	T _A	-40 ~ +85		°C
Storage Temperature	T _{stg}	-40 ~ +85		

A Relative Humidity between 40% and 60% is recommended in ESD-protected work areas to reduce static build up during assembly process (Reference JEDEC/JESD625-A and JEDEC/J-STD-033)

Operating Characteristics (T _A =25°C)		Red (AlGaInP)	Green (AlGaInP)	Unit
Forward Voltage (Typ.) (I _F =20mA)	V _F	1.95	2.1	V
Forward Voltage (Max.) (I _F =20mA)	V _F	2.5	2.5	V
Wavelength of Peak Emission CIE127-2007* (Typ.) (I _F =20mA)	λ _P	645*	574*	nm
Wavelength of Dominant Emission CIE127-2007* (Typ.) (I _F =20mA)	λ _D	630*	570*	nm
Spectral Line Full Width At Half-Maximum (Typ.) (I _F =20mA)	Δλ	28	20	nm
Capacitance (Typ.) (V _F =0V, f=1MHz)	C	35	15	pF

Part Number	Emitting Color	Emitting Material	Lens-color	Luminous Intensity CIE127-2007* (I _F =20mA) mcd		Wavelength CIE127-2007* nm λ _P	Viewing Angle 2θ 1/2
				min.	typ.		
XZMDKVG55W-4	Red	AlGaInP	Water Clear	80	228	645*	140°
				20*	69*		
	Green	AlGaInP		40	79	574*	
				40*	79*		

*Luminous intensity value and wavelength are in accordance with CIE127-2007 standards.

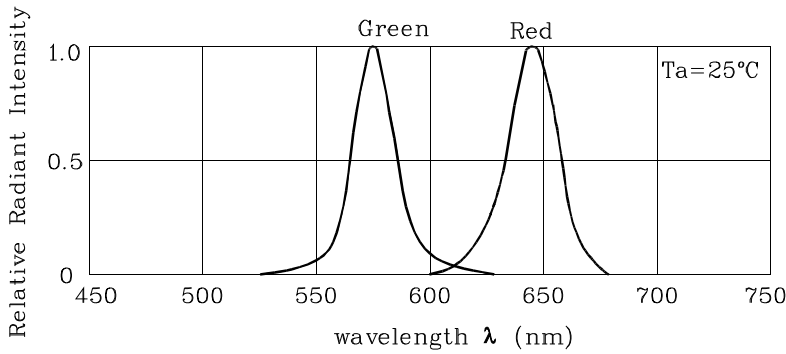

RELATIVE INTENSITY Vs. CIE WAVELENGTH

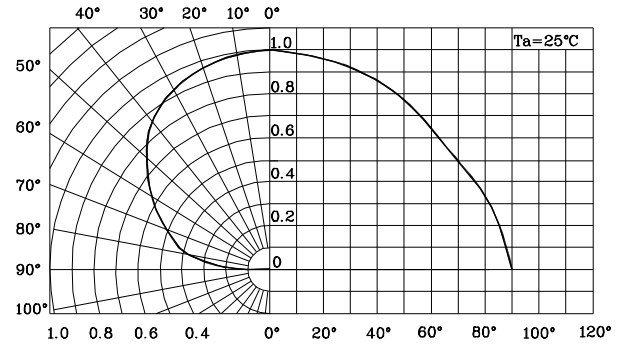

SPATIAL DISTRIBUTION

❖ **Red**

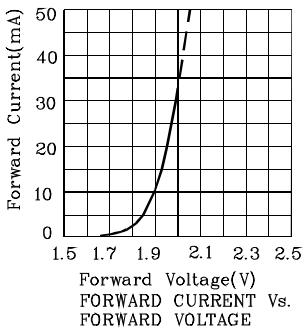

Forward Voltage(V)
FORWARD CURRENT Vs.
FORWARD VOLTAGE

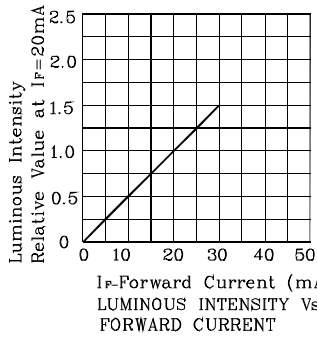

I_f -Forward Current (mA)
LUMINOUS INTENSITY Vs.
FORWARD CURRENT

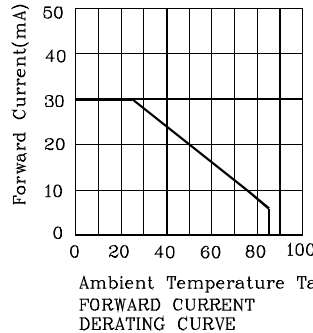

Ambient Temperature T_a ($^\circ\text{C}$)
FORWARD CURRENT
DERATING CURVE

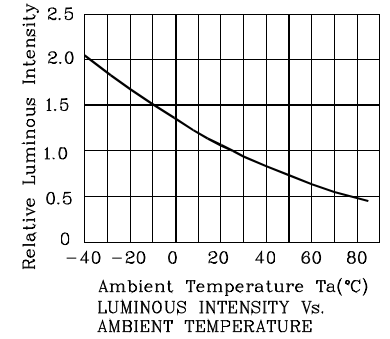

Ambient Temperature T_a ($^\circ\text{C}$)
LUMINOUS INTENSITY Vs.
AMBIENT TEMPERATURE

❖ **Green**

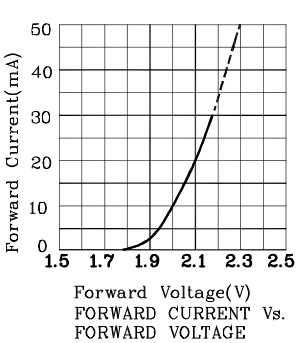

Forward Voltage(V)
FORWARD CURRENT Vs.
FORWARD VOLTAGE

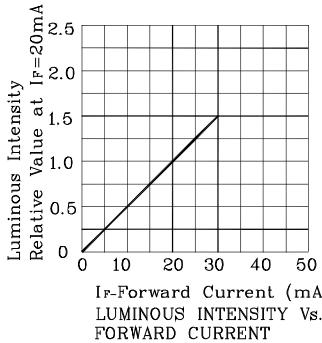

I_f -Forward Current (mA)
LUMINOUS INTENSITY Vs.
FORWARD CURRENT

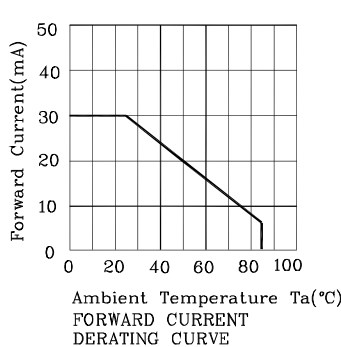

Ambient Temperature T_a ($^\circ\text{C}$)
FORWARD CURRENT
DERATING CURVE

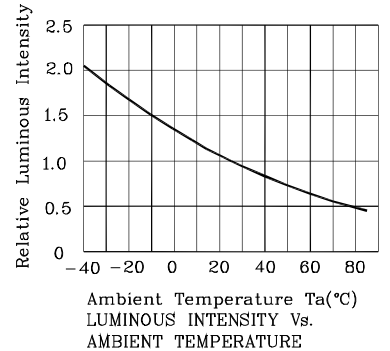

Ambient Temperature T_a ($^\circ\text{C}$)
LUMINOUS INTENSITY Vs.
AMBIENT TEMPERATURE

LED is recommended for reflow soldering and soldering profile is shown below.

❖ The device has a single mounting surface.
The device must be mounted according to the specifications.

Reflow Soldering Profile for SMD Products (Pb-Free Components)

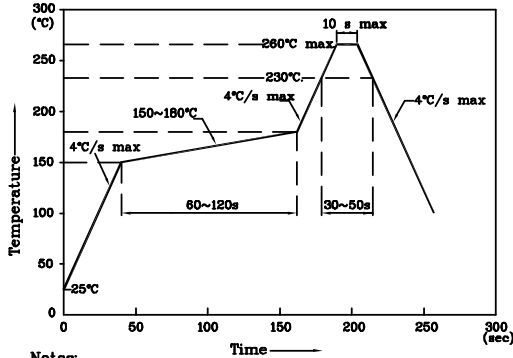

Notes:

1. Maximum soldering temperature should not exceed 260°C
2. Recommended reflow temperature: 145°C-260°C
3. Do not put stress to the epoxy resin during high temperatures conditions

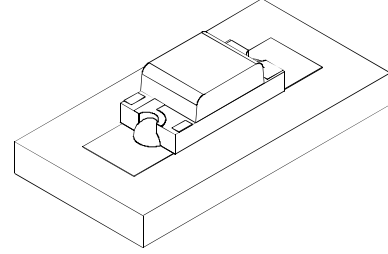

❖ Recommended Soldering Pattern
(Units : mm; Tolerance: ± 0.1)

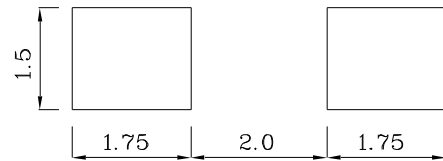

❖ Tape Specification (Units : mm)

❖ Reel Dimension

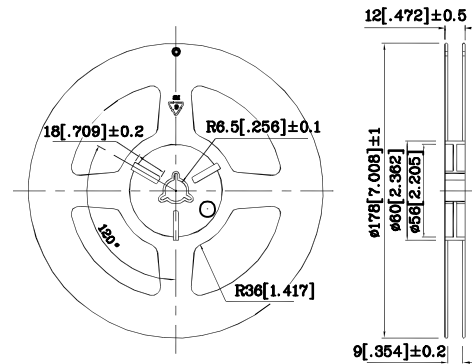
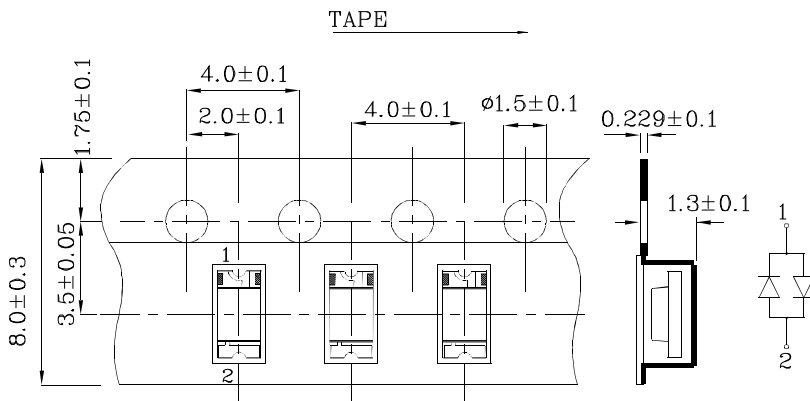

Remarks:



If special sorting is required (e.g. binning based on forward voltage, Luminous intensity / luminous flux, or wavelength), the typical accuracy of the sorting process is as follows:

1. Wavelength: +/-1nm
2. Luminous intensity / luminous flux: +/-15%
3. Forward Voltage: +/-0.1V

Note: Accuracy may depend on the sorting parameters.

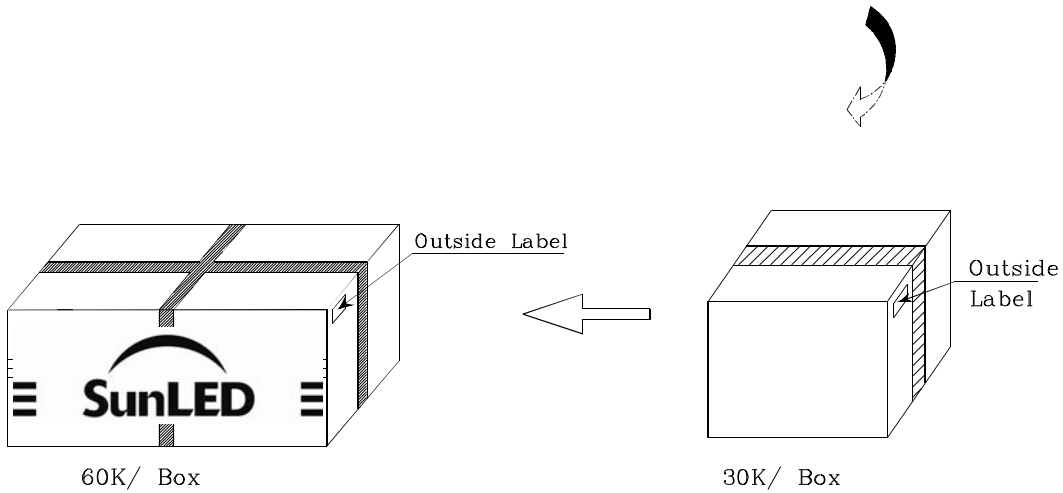
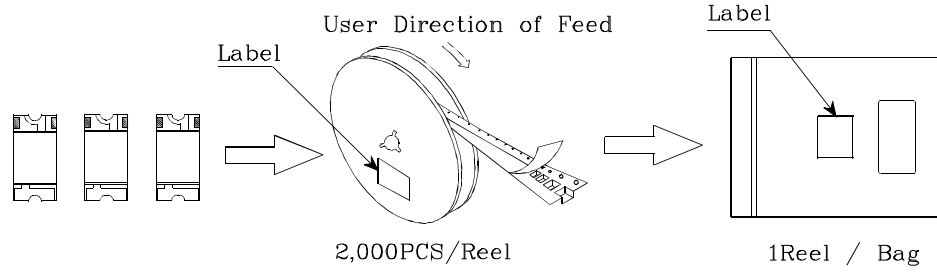
PACKING & LABEL SPECIFICATIONS

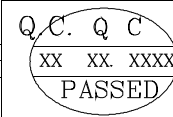

		
P/N0 : XZxxx55x		
QTY : 2,000 PCS	CODE: XXX	
S/N : XX		
LOT NO:		
 xxxxxxxxxxxxxxxxxxxxxxxx		
RoHS Compliant		

TERMS OF USE

1. Data presented in this document reflect statistical figures and should be treated as technical reference only.
2. Contents within this document are subject to improvement and enhancement changes without notice.
3. The product(s) in this document are designed to be operated within the electrical and environmental specifications indicated on the datasheet.
User accepts full risk and responsibility when operating the product(s) beyond their intended specifications.
4. The product(s) described in this document are intended for electronic applications in which a person's life is not reliant upon the LED. Please consult with a SunLED representative for special applications where the LED may have a direct impact on a person's life.
5. The contents within this document may not be altered without prior consent by SunLED.
6. Additional technical notes are available at <http://www.SunLEDusa.com/TechnicalNotes.asp>