

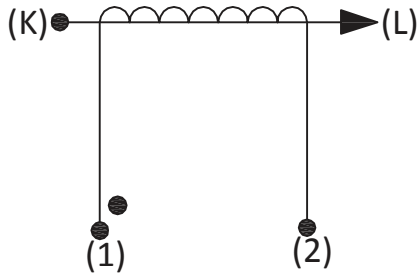

Product Type	Current Transformer
AMGIS Part Number	CT1005

SCHEMATIC:



ELECTRICAL SPECIFICATION:

Rated input current	= 5Amps
Primary to Secondary isolation	= 2500VAC
Operating Frequency	= 50 / 60 Hz
Turns Ratio	= 1 : 1000
DC Resistance	= 41.80 Ω
Output Voltage	= 0.5V @ 5A / 100Ω, 0.0025W
Io @ Vrms : 0.66V	= 237μArms
Ratio Correction factor (RCF*)	= 1.01 @ 10% (Multiply current reading by this factor to compensate for transformer losses)

Volt/Amp at rated Ip for different loads			
100Ω	500Ω	2000Ω	5000Ω
0.10	0.46	1.43	2.01

MECHANICAL SPECIFICATION :

OUTPUT RESPONSE vs INPUT CURRENT @ RATED BURDEN :

Pin Side View

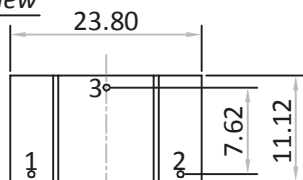

Front View

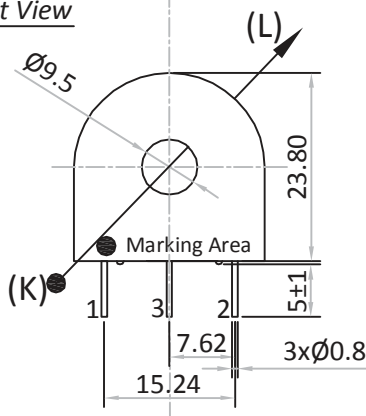

All dimensions are in mm
Linear dimensional tolerance ±0.2mm

Note : Un-Used pin → #3

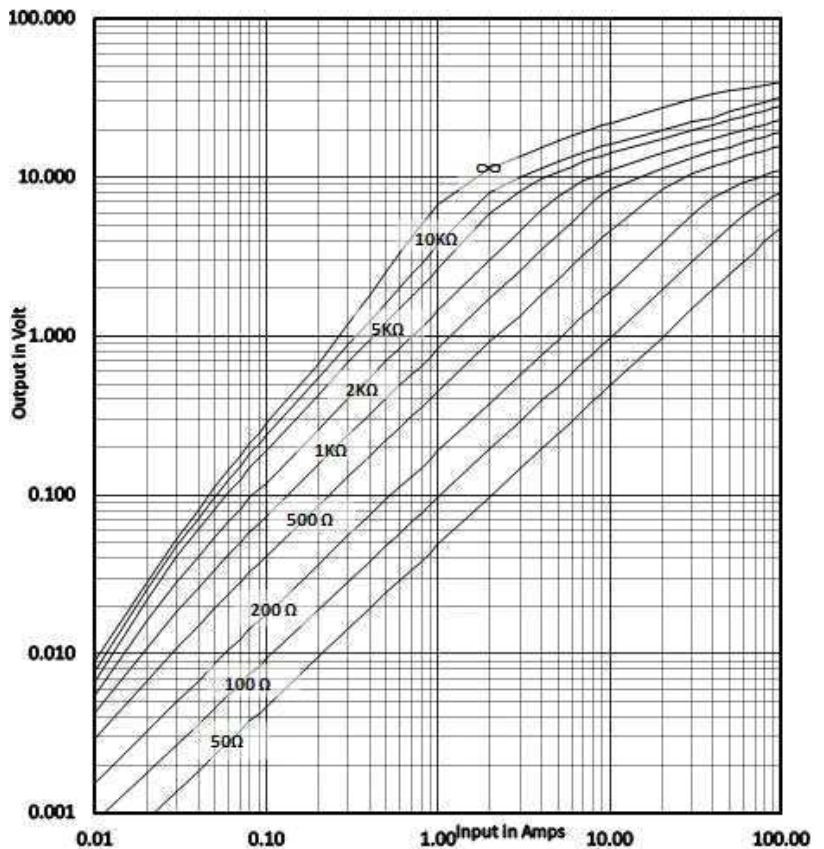

TYPICAL EXCITATION CURVE :

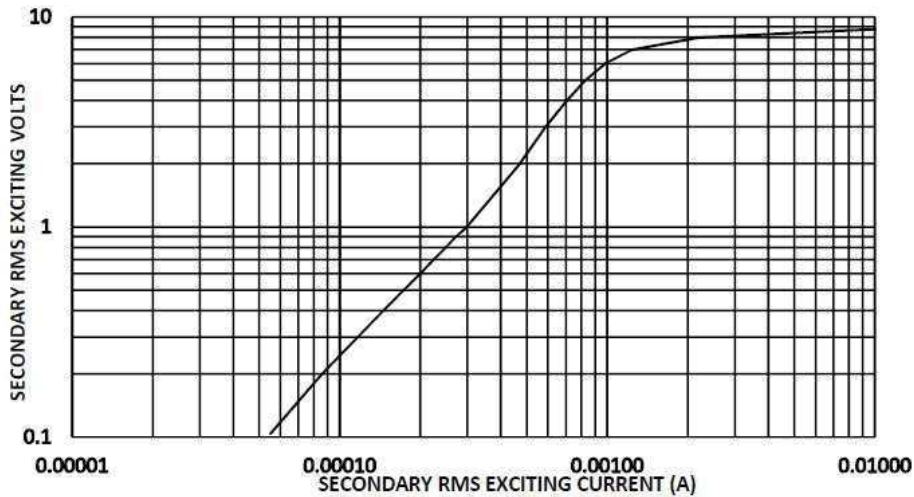

RATIO ERROR (%) vs RATED BURDEN @ INPUT CURRENT :

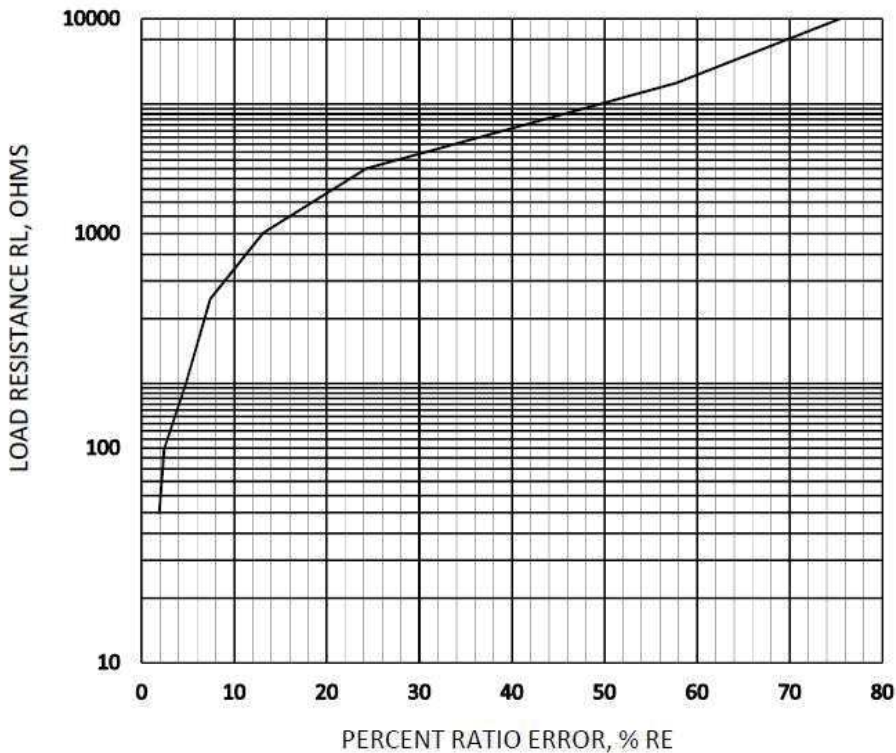

TRAFO WEIGHT:

Approx. Weight = 0.0163 kg / pc

MARKING INFORMATION:

Amgis
CT1005
Yr/Wk code

●
Dot mark for Start pin identification

-----Initial Issue-----	1	0	Balaji. R	18-Nov'2015
Changes	Issue	Rev	Initial	Date