

FRAM click™

1. Introduction

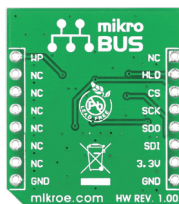
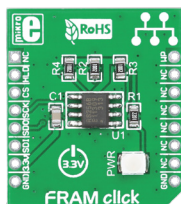

FRAM click™ is an accessory board in **mikroBUS™** form factor. It's a compact and easy solution for adding Ferroelectric Random Access Memory to your design. It features **MB85RS256A** 256K Ferroelectric Random Access Memory. FRAM click™ communicates with the target board microcontroller via **mikroBUS™** SPI (MISO, MOSI, SCK, CS), RST and PWM lines. The board is designed to use 3.3V power supply only. LED (GREEN) indicates the presence of power supply.

2. Soldering the headers

Before using your click board™, make sure to solder 1x8 male headers to both left and right side of the board. Two 1x8 male headers are included with the board in the package.

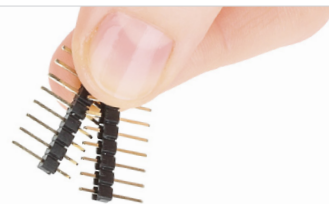

1

2

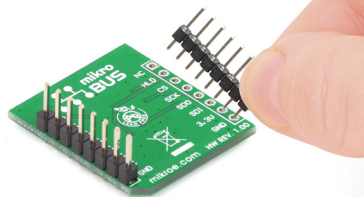

Turn the board upside down so that bottom side is facing you upwards. Place shorter parts of the header pins in both soldering pad locations.

3

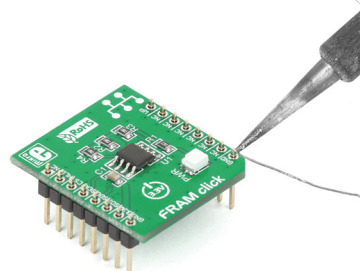

Turn the board upward again. Make sure to align the headers so that they are perpendicular to the board, then solder the pins carefully.

3. Plugging the board in

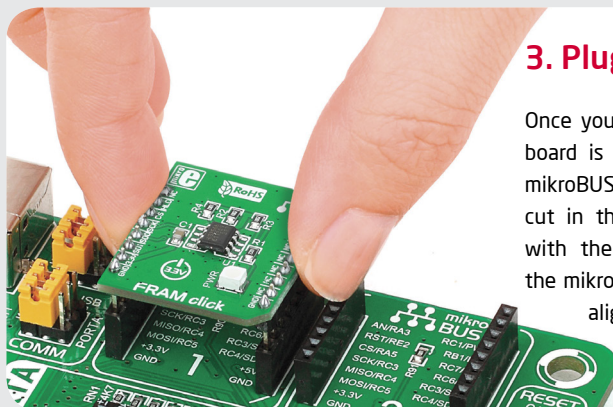

Once you have soldered the headers your board is ready to be placed into desired mikroBUS™ socket. Make sure to align the cut in the lower-right part of the board with the markings on the silkscreen of the mikroBUS™ socket. If all of the pins are aligned correctly, push the board all the way into the socket.

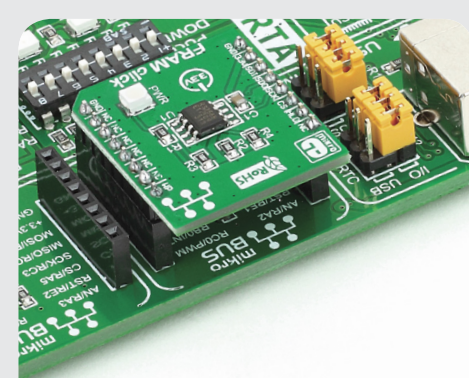

4. Essential features

FRAM click™ with its **MB85RS256A** IC is a 256K FRAM (Ferroelectric Random Access Memory) module which consists of 32,768 words x 8 bits. The **MB85RS256A** use the ferroelectric process and silicon gate CMOS process technologies to form nonvolatile memory cells. This memory can be used for 10^{10} read/write operations, and does not take long time to write data like Flash memories or EEPROM. Maximum operating frequency is 25MHz.

click™
BOARD
www.mikroe.com



FRAM click Manual
ver. 1.00



0 10000 024515

5. FRAM click™ Board Schematic

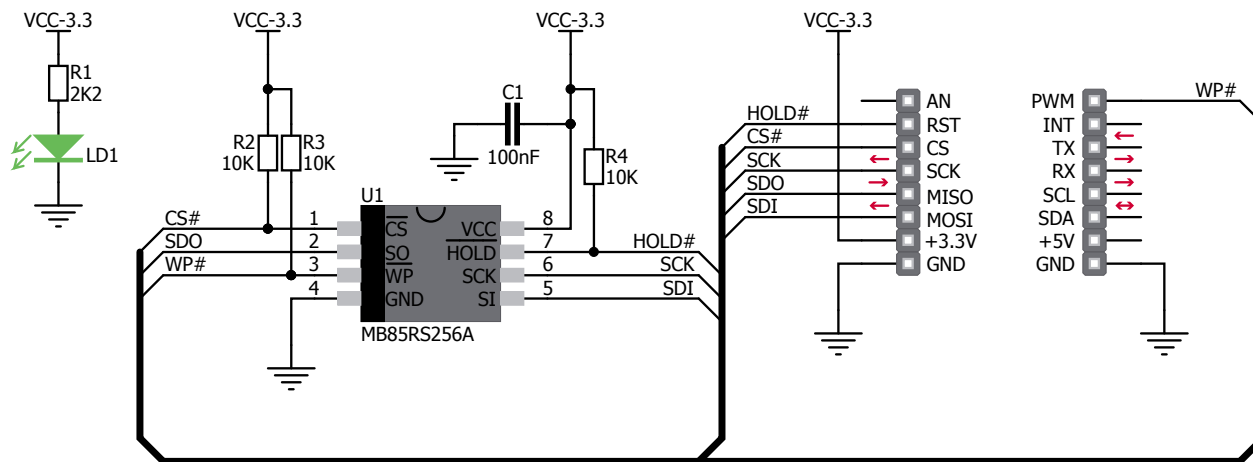

6. Additional pins

FRAM click™ also contains two useful pins: hold (**HOLD**) and write protect (**WP**).

- **HOLD** pin is used to interrupt serial input/output without deselecting chip. When HOLD is "L" level, hold operation is activated, SDO becomes "High-Z", SCK and SI become "Do not care".
- **WP** is used to control writing to a status register. When WP is "L" level, writing to a status register is disabled.

7. Code Examples

Once you have done all the necessary preparations, it's time to get your click board up and running. We have provided the examples for mikroC, mikroBasic and mikroPascal compilers on our **Libstock** website. Just download them and you are ready to start.



8. Support

MikroElektronika offers **Free Tech Support** (www.mikroe.com/esupport) until the end of product lifetime, so if something goes wrong, we are ready and willing to help!