

PART NO.	JLL-101A	WIRE	SCALE	1 : 1
DESCRIPTION	SPT-1#18*2C	60C	UNIT:	mm
DWG No.	800-1808-0-SPT1-BL-0009F			

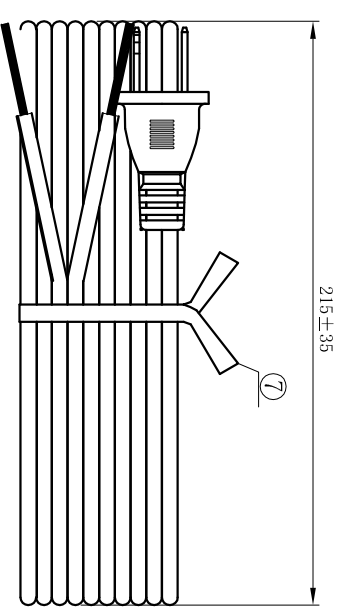
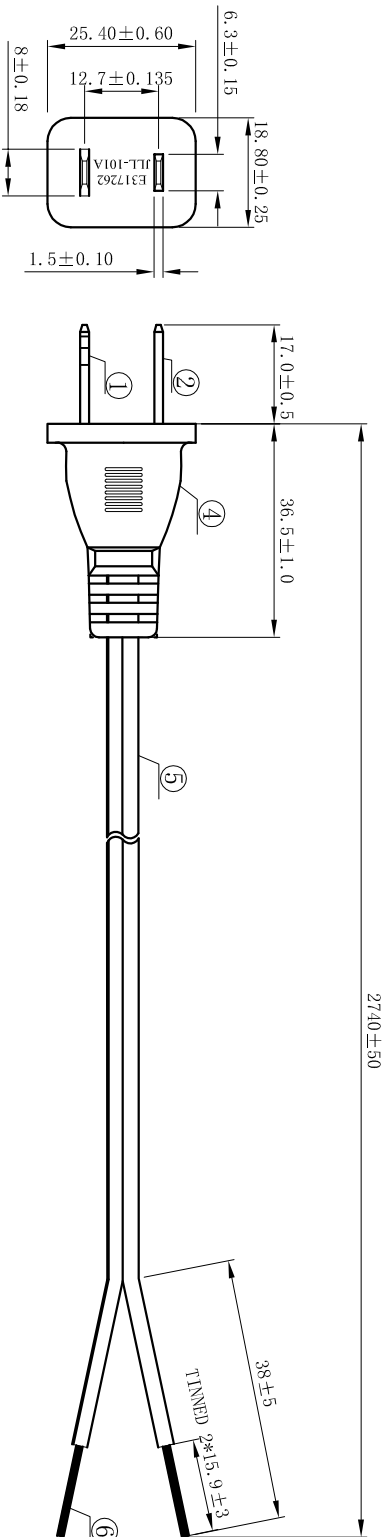

NOTES:
CONDUCTOR CONSTRUCTION(N/mm):
41/0.16AS

1) JACKET COLOR: BLACK

TESTING:

- 1) 100% OPEN & SHORT TESTING
- 2) INSULATION RESISTANCE: 100M ohm (min)
- 3) VOLTAGE: DC500V/1min
- 4) ROHS COMPLIANT

Printing the contents of wire The use of printing ink replenish Wire

E243711 (UL) SPT-1 2 X 18AWG(0.82mm²) VW-1 60°C 300V CSA 228191 SPT-1 2 X 18AWG(0.82mm²) FT2 60°C 300V JINJIANJI -1P-

NO.	SPECIFICATION	COLOUR	MATERIAL	AMOUNT
①	Terminal polarity 98662	Silver	Cu	1P
②	Non-polar terminal 98661	Silver	Cu	1P
③	Model aircraft 8661AN-2P	WHITE	PBT	1PCS
④	Plug JLL-101A	BLACK	PVC Cu	1PCS
⑤	Wire SPT-1 18AWG/2C 60°C	BLACK	PVC Cu	1PCS
⑥	tin	Silver	Article tin	2PCS
⑦	Ties	BLACK		1PCS

REV	DATE	DESCRIPTION	SYMBOL
DRAWN/DATE	CHECKED/DATE	GONG/11.05.13	