

BRACKET ASSEMBLY
MOUNTING HARDWARE

FB3BRACKET

Series : ANTENNA

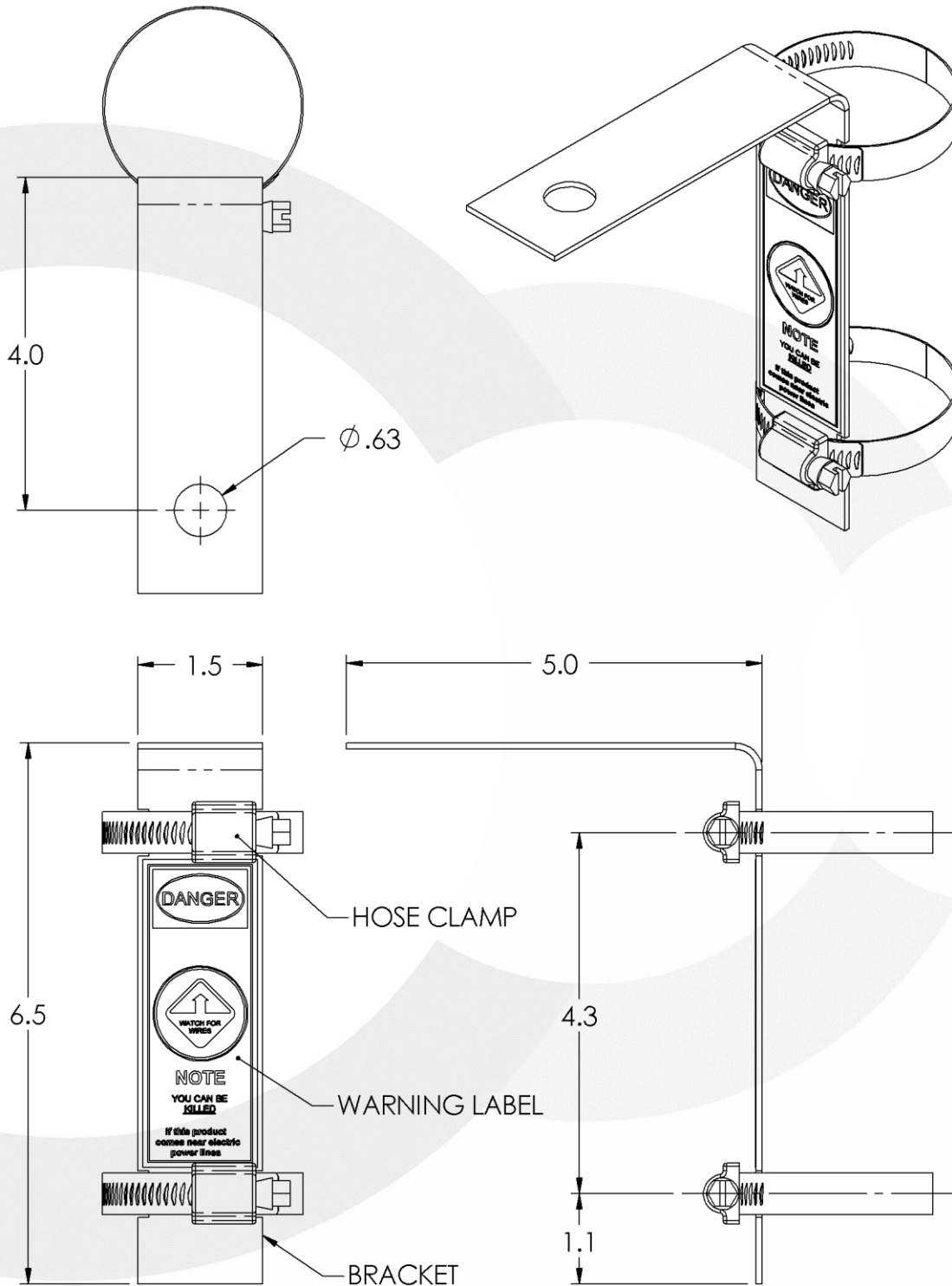

All dimensions are in inches

Issue : 0710

In the effort to improve our products, we reserve the right to make changes judged to be necessary.



BRACKET ASSEMBLY
MOUNTING HARDWARE

FB3BRACKET

Series : ANTENNA

MECHANICAL SPECIFICATIONS

Material :

Bracket : **14 ga. steel, zinc plated**

Hose Clamp : **Stainless steel**

Weight : **200 g**

Overall length : **6.5 INCHES**

Fixing system : **2 ¼ inch hose clamp**

ENVIRONMENTAL SPECIFICATIONS

Operating temperature : **-30 to +160 ° F**