



**Z8051™ Family of 8-Bit Microcontrollers**

# **Z51F3220 Development Kit**

**User Manual**

UM024307-1112





**Warning:** DO NOT USE THIS PRODUCT IN LIFE SUPPORT SYSTEMS.

---

## **LIFE SUPPORT POLICY**

ZILOG'S PRODUCTS ARE NOT AUTHORIZED FOR USE AS CRITICAL COMPONENTS IN LIFE SUPPORT DEVICES OR SYSTEMS WITHOUT THE EXPRESS PRIOR WRITTEN APPROVAL OF THE PRESIDENT AND GENERAL COUNSEL OF ZILOG CORPORATION.

### **As used herein**

Life support devices or systems are devices which (a) are intended for surgical implant into the body, or (b) support or sustain life and whose failure to perform when properly used in accordance with instructions for use provided in the labeling can be reasonably expected to result in a significant injury to the user. A critical component is any component in a life support device or system whose failure to perform can be reasonably expected to cause the failure of the life support device or system or to affect its safety or effectiveness.

### **Document Disclaimer**

©2012 Zilog, Inc. All rights reserved. Information in this publication concerning the devices, applications, or technology described is intended to suggest possible uses and may be superseded. ZILOG, INC. DOES NOT ASSUME LIABILITY FOR OR PROVIDE A REPRESENTATION OF ACCURACY OF THE INFORMATION, DEVICES, OR TECHNOLOGY DESCRIBED IN THIS DOCUMENT. ZILOG ALSO DOES NOT ASSUME LIABILITY FOR INTELLECTUAL PROPERTY INFRINGEMENT RELATED IN ANY MANNER TO USE OF INFORMATION, DEVICES, OR TECHNOLOGY DESCRIBED HEREIN OR OTHERWISE. The information contained within this document has been verified according to the general principles of electrical and mechanical engineering.

Z8051 is a trademark or registered trademark of Zilog, Inc. All other product or service names are the property of their respective owners.

# Revision History

Each instance in the Revision History table below reflects a change to this document from its previous version.

Date	Revision Level	Description	Page
Nov 2012	07	Corrected pin values in Default Jumper Settings table.	<a href="#">6</a>
Sep 2012	06	Replaced incorrect screen in Figure 27.	<a href="#">31</a>
Sep 2012	05	Updates for Z8051 Installation Software release 2.0.	<a href="#">20</a> , <a href="#">26</a> , <a href="#">33</a> , <a href="#">45–46</a>
Apr 2012	04	Updated for improved usability.	All
Mar 2012	03	Added a G to end of part number to indicate RoHS compliance; added Figure 21.	<a href="#">25</a>
Mar 2012	02	Corrected filepaths in the Build and Run the Z51F3220 Demo Project section.	<a href="#">20</a>
Feb 2012	01	Original issue.	All

# Table of Contents

Revision History . . . . .	iii
List of Figures . . . . .	v
List of Tables . . . . .	vii
Introduction . . . . .	1
Kit Contents . . . . .	2
Supported Operating Systems . . . . .	3
Z51F3220 Development Board Block Diagram . . . . .	3
Z51F3220 Development Board Description . . . . .	4
Install the Z8051 OCD Software and Documentation . . . . .	7
Z8051 OCD Driver Installation . . . . .	7
FTDI USB-to-UART Driver Installation . . . . .	15
Configure the Z8051 OCD and Z51F3220 Development Board . . . . .	17
Build and Run the Z51F3220 Demo Project . . . . .	20
Using the Keil $\mu$ Vision IDE on a Demo Project . . . . .	26
HyperTerminal Configuration . . . . .	33
Sample Projects and Documentation . . . . .	36
Schematic Diagrams . . . . .	37
OCD Driver Installation on Windows Vista Systems . . . . .	39—
OCD Driver Installation on Windows XP Systems . . . . .	42—
Stand-Alone Flash Programming Using the Keil $\mu$ Vision IDE . . . . .	45—
Customer Support . . . . .	47

# List of Figures

Figure 1.	The Z51F3220 Development Kit . . . . .	2
Figure 2.	Z51F3220 Development Board . . . . .	3
Figure 3.	Block Diagram of the Z51F3220 Development Board . . . . .	4
Figure 4.	Z51F3220 Development Board: Highlighted Components . . . . .	5
Figure 5.	Install Device Driver Dialog, Windows 7 . . . . .	8
Figure 6.	Browse For Driver Dialog, Windows Vista . . . . .	9
Figure 7.	Can't Verify Publisher Dialog, Windows Vista . . . . .	10
Figure 8.	Successfully Installed Dialog, Windows Vista . . . . .	11
Figure 9.	Unsuccessful Installation, Scenario 1 . . . . .	12
Figure 10.	Unsuccessful Installation, Scenario 2 . . . . .	13
Figure 11.	Device Manager Dialog, Windows 7 . . . . .	14
Figure 12.	A Successful USB-to-UART Driver Installation . . . . .	16
Figure 13.	Connecting the 10-Circuit Cable to the Board . . . . .	17
Figure 14.	Connecting the USB Mini-B Cable to the Board . . . . .	18
Figure 15.	An Example Setup . . . . .	19
Figure 16.	Initial OCD Screen . . . . .	21
Figure 17.	Object File Dialog . . . . .	22
Figure 18.	Configuration Dialog . . . . .	23
Figure 19.	Configuration Is Changed Dialog . . . . .	24
Figure 20.	A Typical On-Chip Debugger Window . . . . .	24
Figure 21.	A Typical On-Chip Debugger Window with Child Windows Open . . . . .	25
Figure 22.	Reset & Go Toolbar Icon . . . . .	25
Figure 23.	Selecting the Demo Project File . . . . .	27
Figure 24.	Selecting the Target . . . . .	28
Figure 25.	Selecting the Target Driver . . . . .	29
Figure 26.	Configuring the Debug Options . . . . .	30
Figure 27.	Configuring the Flash Options . . . . .	31
Figure 28.	Load Application at Startup Settings . . . . .	31

Figure 29. Beginning a Debug Session .....	32
Figure 30. A Default Debug Session .....	32
Figure 31. Demo Program Menu in HyperTerminal .....	34
Figure 32. Z51F3220 Development Board, #1 of 2 .....	37
Figure 33. Z51F3220 Development Board, #2 of 2 .....	38
Figure 34. Found New Hardware Dialog, Windows Vista .....	39
Figure 35. Install Device Driver Dialog, Windows Vista .....	40
Figure 36. Couldn't Find Driver Dialog, Windows Vista .....	41
Figure 37. The Found New Hardware Wizard Welcome Screen .....	42
Figure 38. The Found New Hardware Wizard's Browse Screen .....	43
Figure 39. Selecting A Target Driver For Flash Programming .....	45
Figure 40. Configuring Additional Flash Options .....	46
Figure 41. The Keil IDE Flash Menu .....	46

# List of Tables

Table 1.	Z51F3220000ZCOGG Contents .....	2
Table 2.	Default Jumper Settings .....	6
Table 3.	Z51F3220 Development Kit Sample Projects .....	36
Table 4.	Z51F3220 Development Kit Documentation .....	36

# Introduction

This manual describes how to set up Zilog's Z51F3220 Development Kit (Zilog part number Z51F3220000ZCOG) and use it to evaluate your Z8051-based designs and applications.

The Kit features a development board consisting of five LEDs, five pushbuttons, a buzzer, four 7-segment LCD digits, port pin headers and a UART-to-USB port. The Board features the Z51F3220 MCU in a 44-pin MQFP package, plus a DBG connector to connect the Board to a host development PC using the Z8051 USB On-Chip Debugger (OCD) cable. For more details about the Z51F3220 MCU, please refer to the [Z51F3220 Product Specification \(PS0299\)](#).

This document guides you through the following tasks:

- [Install the Z8051 OCD Software and Documentation](#) – see page 7
- [Configure the Z8051 OCD and Z51F3220 Development Board](#) – see page 17
- [Build and Run the Z51F3220 Demo Project](#) – see page 20

Figure 1 displays an image of the Z51F3220 Development Kit.





Figure 1. The Z51F3220 Development Kit

## Kit Contents

Table 1 lists the contents of the Z51F3220 Development Kit.

Table 1. Z51F3220000ZCOGG Contents

Item	Description	Quantity
1	Z51F3220 Development Board	1
2	Z8051 USB On-Chip Debugger (OCD)	1
3	Z8051 OCD Target Cable (10ct)	1
4	USB Cable: A (male) to Mini-B	2
5	Z8051 OCD Software and Documentation CDROM	1
6	Z51F3220 Development Kit Insert (FL0139)	1

[Appendix 2](#) on page 3 displays an image of the Z51F3220 Development Board.

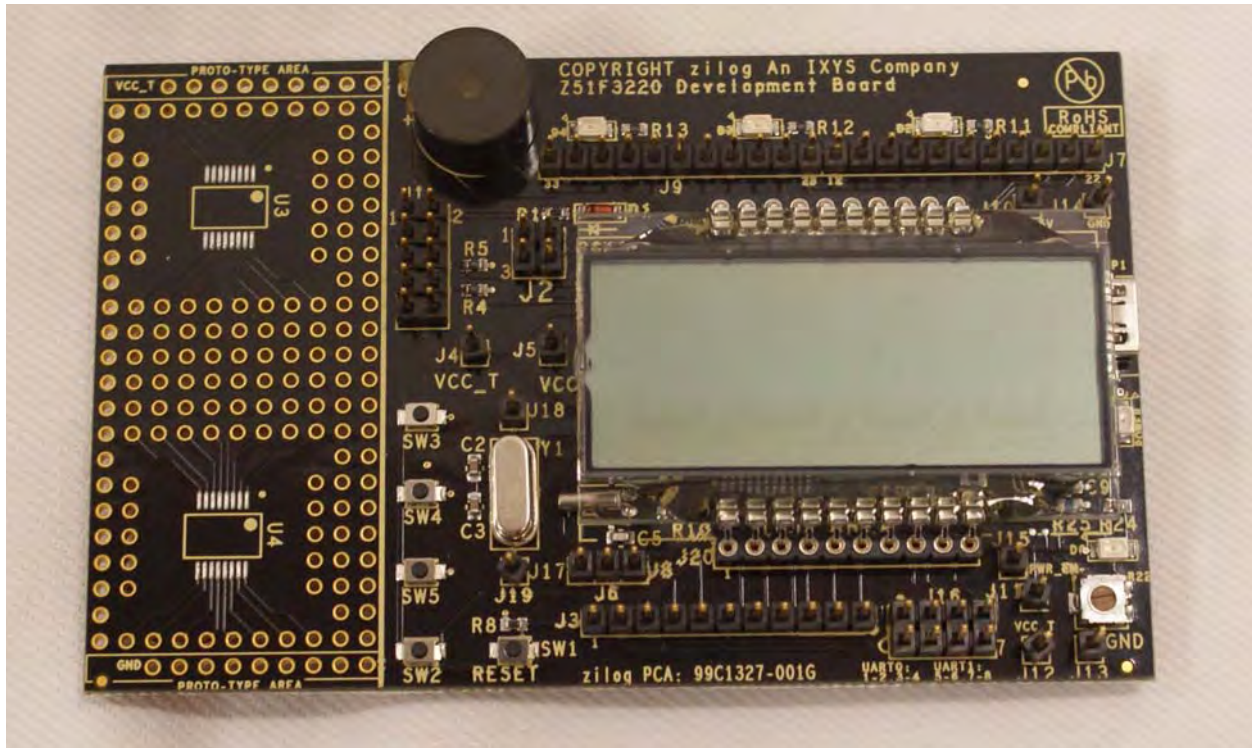

Figure 2. Z51F3220 Development Board

## Supported Operating Systems

The Z51F3220 Development Board and the Z8051 On-Chip Debugger support the following operating systems:

- Microsoft Windows XP
- Microsoft Windows Vista (32-bit/64-bit)
- Microsoft Windows 7 (32-bit/64-bit)

## Z51F3220 Development Board Block Diagram

Figure 3 displays a block diagram of the Z51F3220 Development Board.

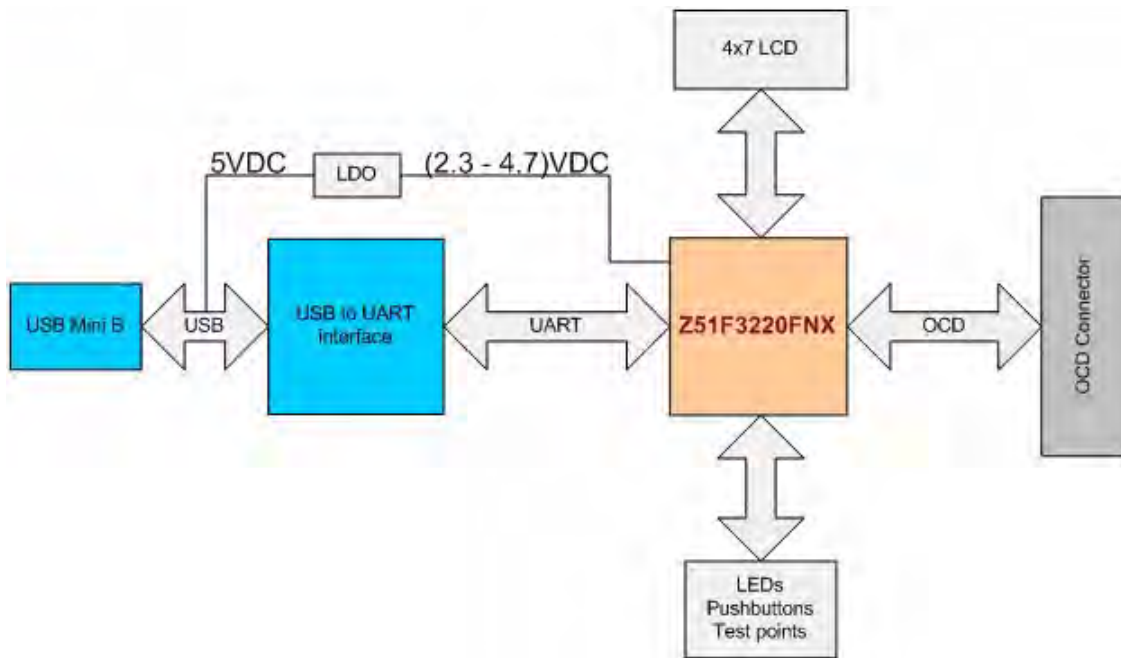

Figure 3. Block Diagram of the Z51F3220 Development Board

## Z51F3220 Development Board Description

The Z51F3220 Development Board consists of the following components:

- Z51F3220: U2, 44-pin MQFP chip
- 3 LEDs: Green (D2), Red (D3) and Yellow (D4) connected to the GPIO pins of the Z51F3220 MCU
- 1 green LED to indicate USB power: D5
- 1 red LED to indicate an overcurrent condition: D6
- 5 pushbuttons:
  - SW1: RESET
  - SW2–SW5: connected to the GPIO pins of the Z51F3220 MCU
- USB connector: P1
- OCD connector: J1
- USB-to-UART interface: U7

- USB interface providing power and communication to the Board through adjustable LD0: U5
- Power supply level that can be adjusted with potentiometer R22
- Overcurrent protection circuit on the Board: U6 and D6
- External source of reference voltage (2.5V) for the on-chip ADC: VR1
- MCU current consumption measurement resistor R7 with test points J4 and J5
- Buzzer: U1
- 4-digit, 7-segment LCD panel
- Test points, headers and prototype area with two footprints

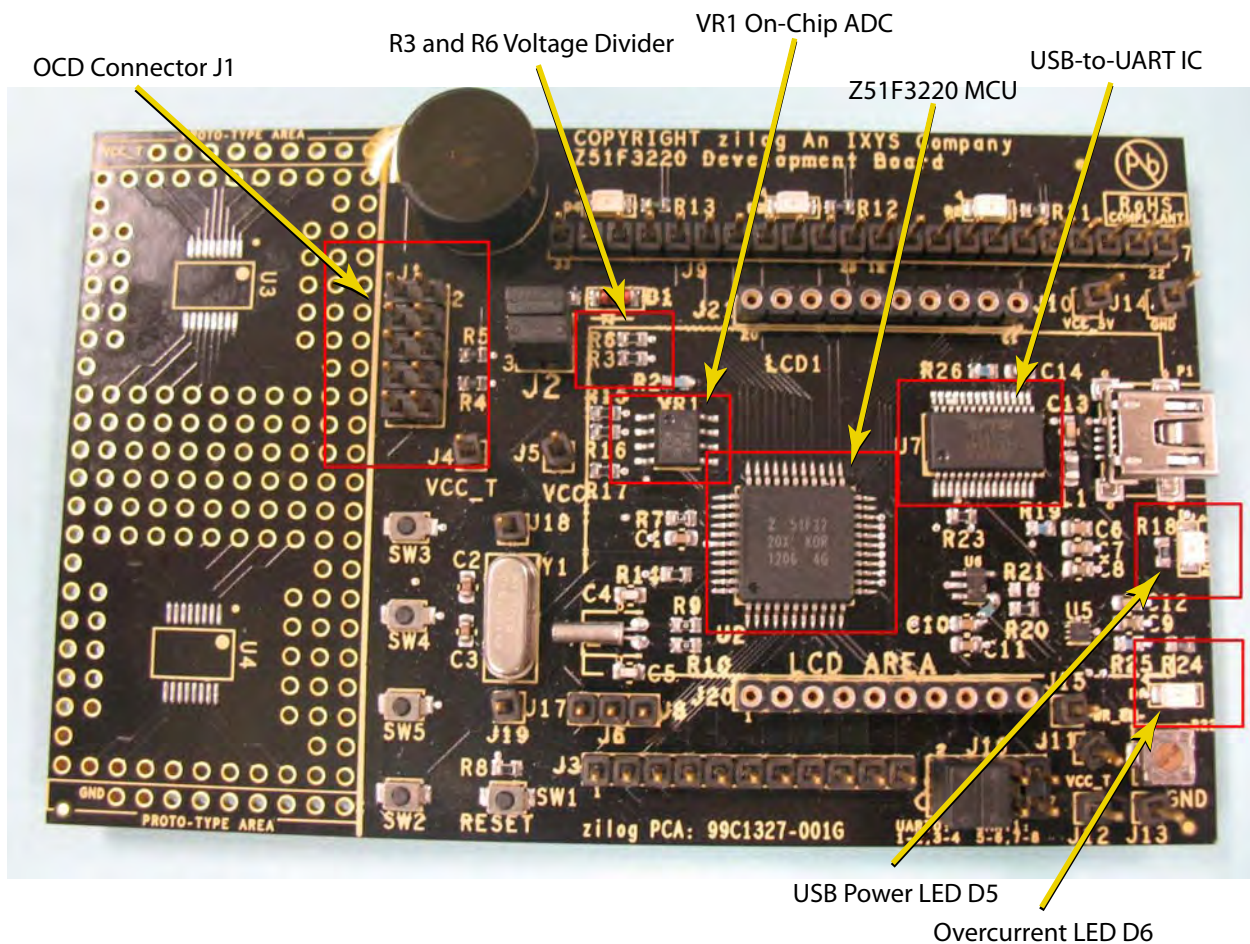

Figure 4. Z51F3220 Development Board: Highlighted Components

By default, the Z51F3220 Development Board is set up with preinstalled shunts on J16 jumper pins 1–2 and 3–4 to allow the interfacing of the Z51F3220 MCU’s UART0 to the USB port. When the Board is connected to the USB port of the host PC, LED D5 will be ON. The default settings and functionalities of these shunts are listed in Table 2.

**Table 2. Default Jumper Settings**

Headers	Pins	Functionality	Notes
J16	1–2, 3–4	UART0 to USB	Default
J16	5–6, 7–8	UART1 to USB	
J2	1–2	$V_{CC}$ is being measured by AN1	Default
J2	3–4	External $V_{REF}$ , 2.5V is used for ADC	Default

As indicated in the table, should you decide to use the the Z51F3220 MCU’s UART1 block as the interface for your own project (currently not supported in this release), move the J16 shunts to positions 5–6 and 7–8.

By default, Input 1 of the ADC is used to measure the supply voltage. This measurement point is taken from a middle point in the voltage divider circuit that includes resistors R3 and R6; the scaling is performed by software so that the LCD always displays the actual voltage. For a visual representation, see the schematic diagram in [Figure 32](#) on page 37.

If a short on the Board should occur, or if its attached component(s) require more than 500mA, the overcurrent protection functionality will trigger the red LED D6 to illuminate. In this instance, power to the Board will be terminated, and the USB port of the PC will be protected from shorting.

Schematic diagrams of the Z51F3220 Development Board are presented [on pages 37 and 38](#) of this document.

The physical dimensions of the Board are 4.01" x 2.50" (101.8mm x 63.5mm).

# Install the Z8051 OCD Software and Documentation

The Z8051 On-Chip Debugger (OCD) interface is the interface by which your PC will communicate with the Z51F3220 MCU to download and execute code. In addition to the OCD, software such as development tools and sample applications will be installed.

---

► **Note:** If you have already installed the Z8051 software and documentation from the CD-ROM following the procedure on the paper insert in your kit (FL0139), skip this section and proceed to the Z8051 OCD Driver Installation section, below.

---

Observe the following procedure to install the Z8051 On-Chip Debugger software and documentation on your computer.

1. Ensure that the OCD interface hardware is not connected to your PC.
2. Insert the Z8051 Software and Documentation CD into your computer's CD-ROM drive. The setup program launches automatically. If the setup program does not launch automatically, open Windows Explorer, browse to your CD-ROM drive, and double-click the file labeled `z8051_<version_number>.exe`.

---

► **Note:** In this filename, `<version_number>` refers to the version number of the OCD Software and Documentation release. For example, this version number may be 1.0.

---

3. Follow the on-screen instructions to complete the OCD software installation.

## Z8051 OCD Driver Installation

The driver programs for the Z8051 On-Chip Debugger are copied during the software and documentation installation. In the following procedure for PCs running the Windows 7 32- and 64-bit operating systems, ensure that the target side of the OCD will remain unconnected while you install these drivers.

---

► **Note:** If you are running Windows Vista, see [Appendix A](#) on page 39 to install your device drivers. If you are running Windows XP, see [Appendix B](#) on page 42.

---

1. Connect the OCD hardware to the USB port of your PC by connecting the A (male) end of one of the two USB A (male)-to-Mini-B cables with the host PC's USB port. Connect the Mini-B end to the OCD device.
2. After the PC detects the new hardware, it will display the *Installing device driver software* dialog shown in Figure 5.

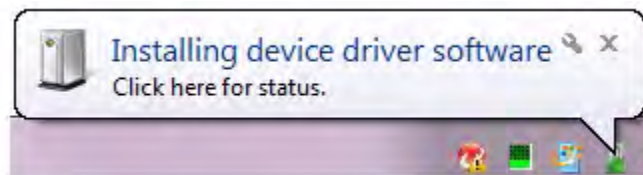

Figure 5. Install Device Driver Dialog, Windows 7

**IMPORTANT NOTE:** If you should encounter the scenarios presented in Figures 9 or 10, right-click your mouse on **ZILOG OCD I/F** (highlighted in Figure 9) or **Unknown device** (highlighted in Figure 10) and select **Update Driver Software...**

3. Select **Browse my computer for driver software (advanced)** to display the dialog shown in Figure 6, which prompts you to key in or browse for the location of the .inf file. Depending on the type of computer you use (32-bit or 64-bit), use the **Browse** button to navigate to one of the following paths, then click the **Next** button.
  - On 32-bit machines, use the following path:  
<Z8051 Installation>\Z8051\_<version\_number>\device drivers\OCD USB\x32
  - On 64-bit machines, use the following path:  
<Z8051 Installation>\Z8051\_<version\_number>\device drivers\OCD USB\x64

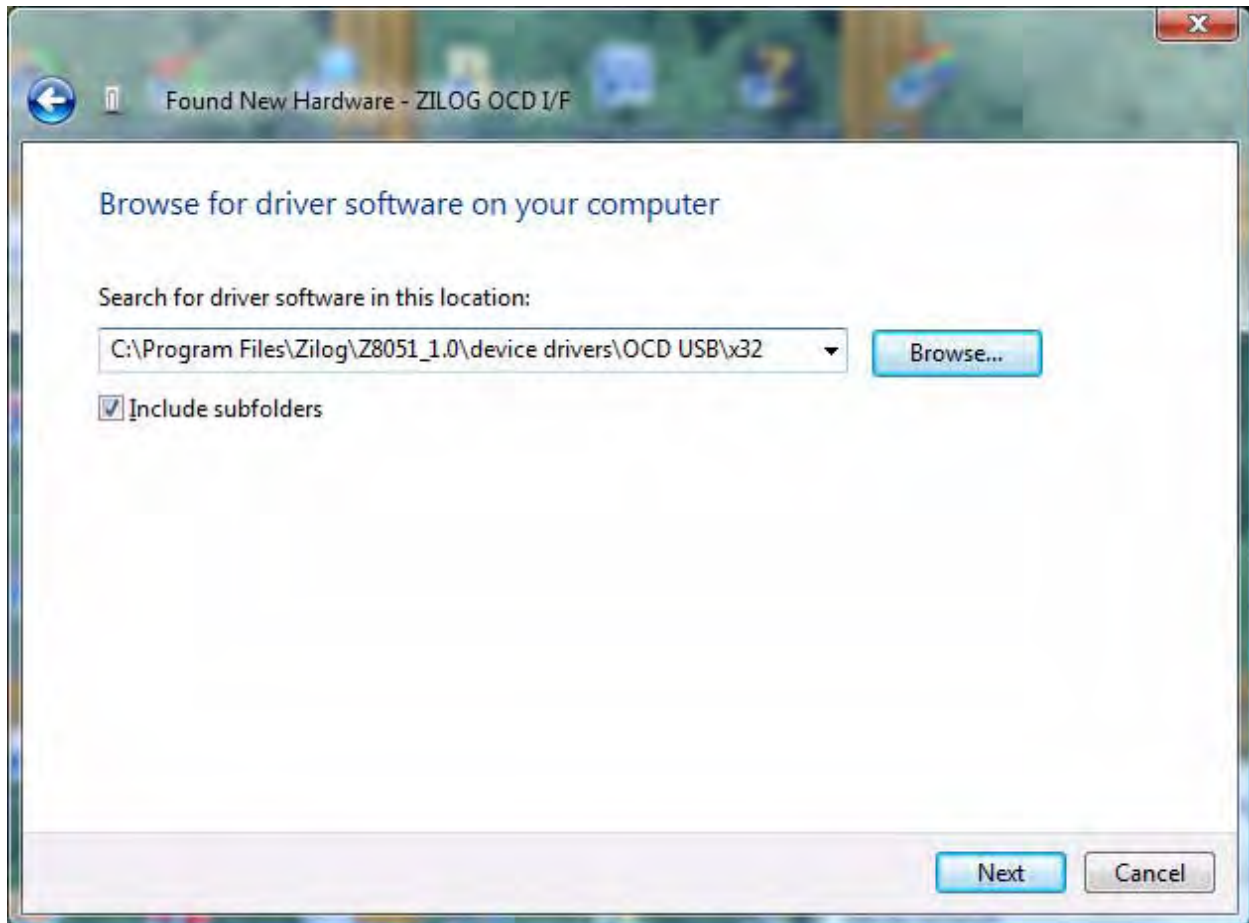

Figure 6. Browse For Driver Dialog, Windows Vista



4. When Windows prompts you whether to install or not install, as shown in Figure 7, click **Install this driver software anyway** and wait until the installation is completed (Windows may prompt you more than once).

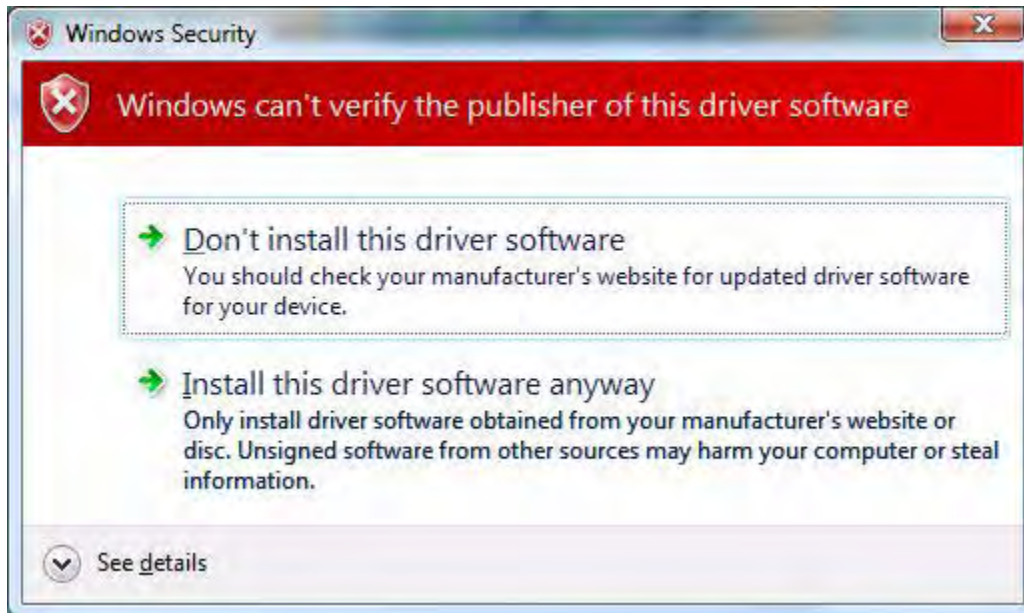
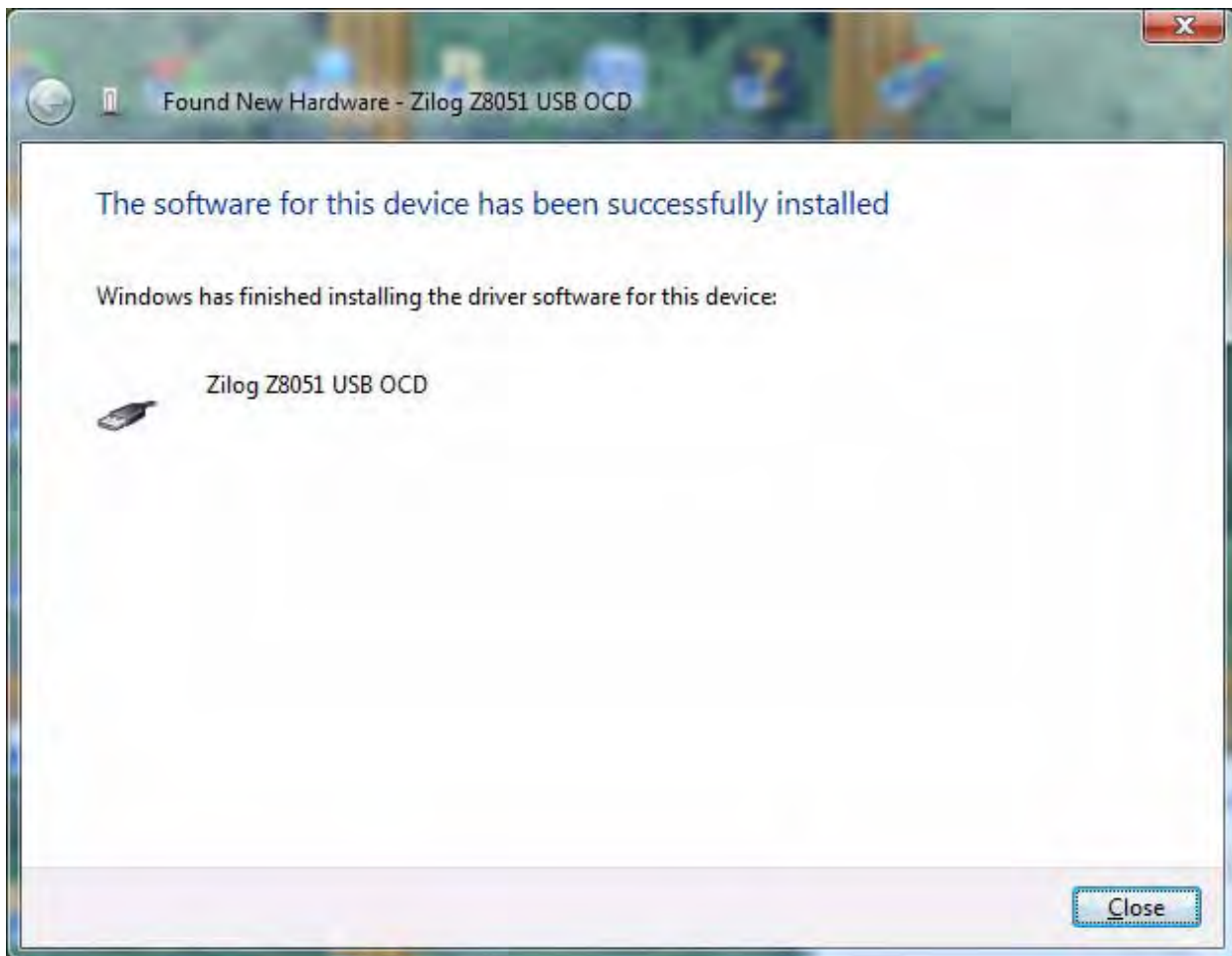

Figure 7. Can't Verify Publisher Dialog, Windows Vista

5. When the installation is complete, the screen shown in Figure 8 will appear. Click **Close** to exit the OCD driver installation.



**Figure 8. Successfully Installed Dialog, Windows Vista**

- 
- **Note:** On some installations, the Found New Hardware screen shown in Figure 8 may also display the text string, Zilog Z8051 USB OCD - No Firmware. This occurrence is normal and can be disregarded.
-

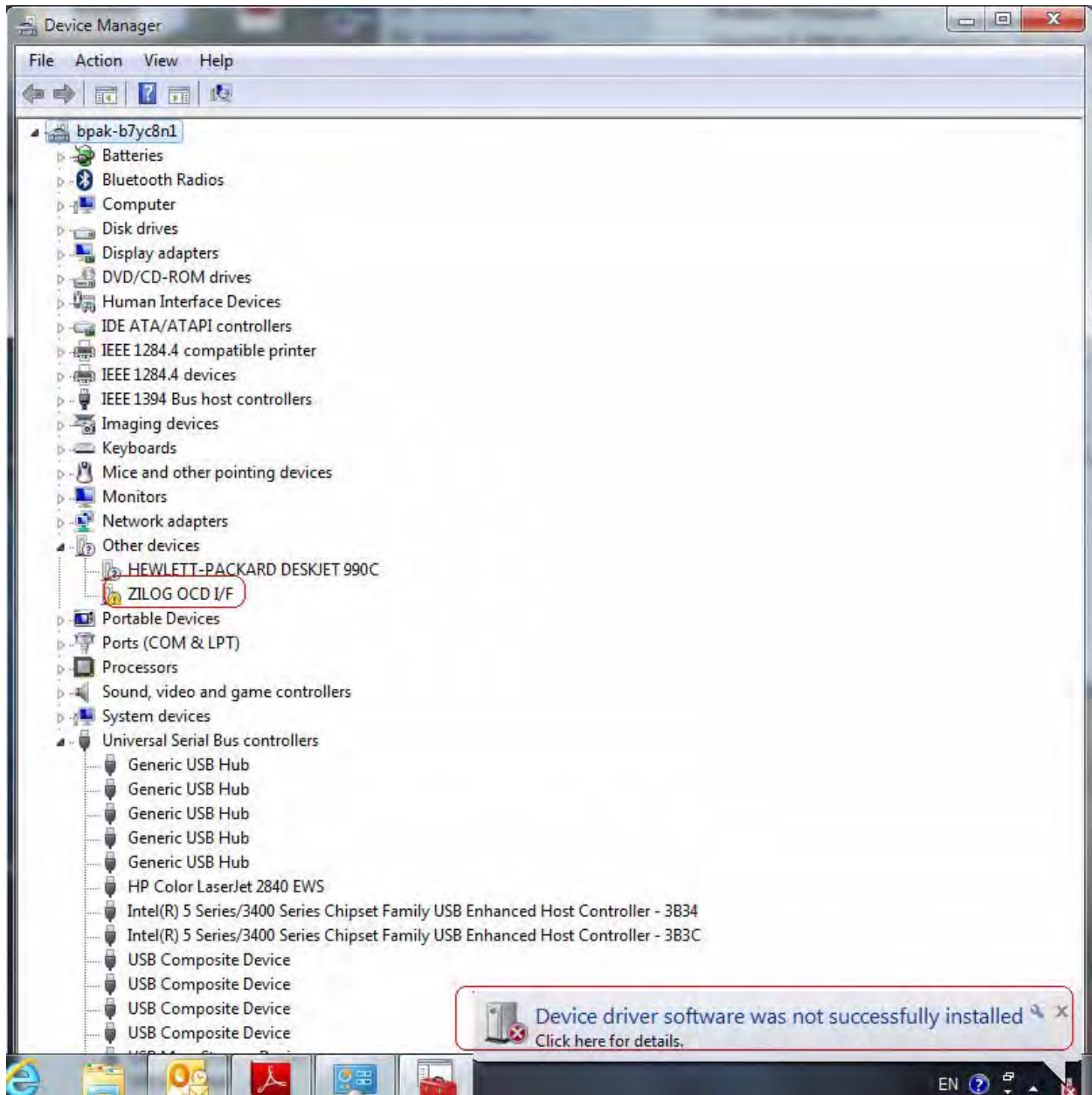

Figure 9. Unsuccessful Installation, Scenario 1

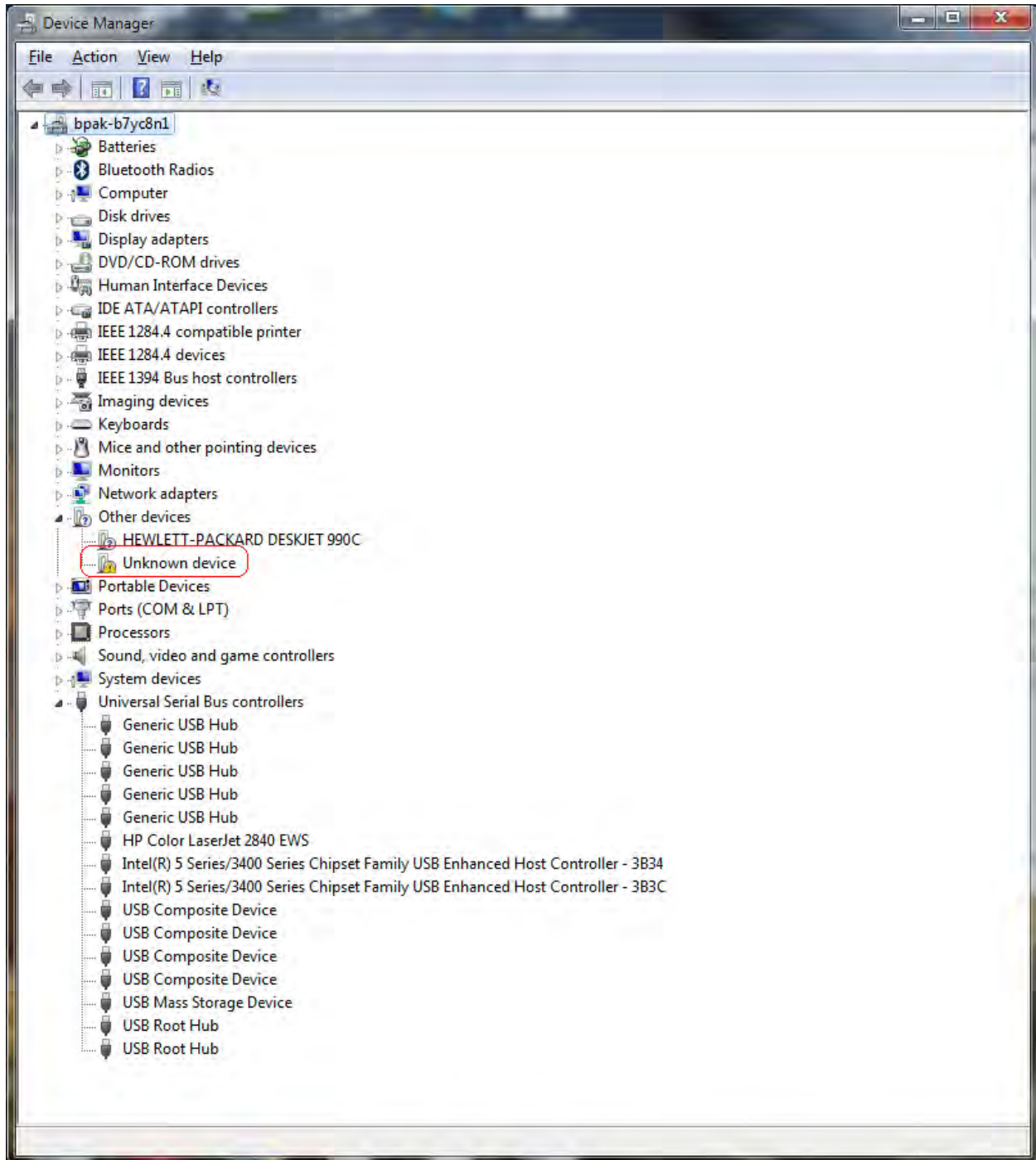

Figure 10. Unsuccessful Installation, Scenario 2

6. If *Zilog Z8051 USB OCD* appears in the Device Manager (as highlighted in Figure 11), the OCD driver software has been successfully installed.

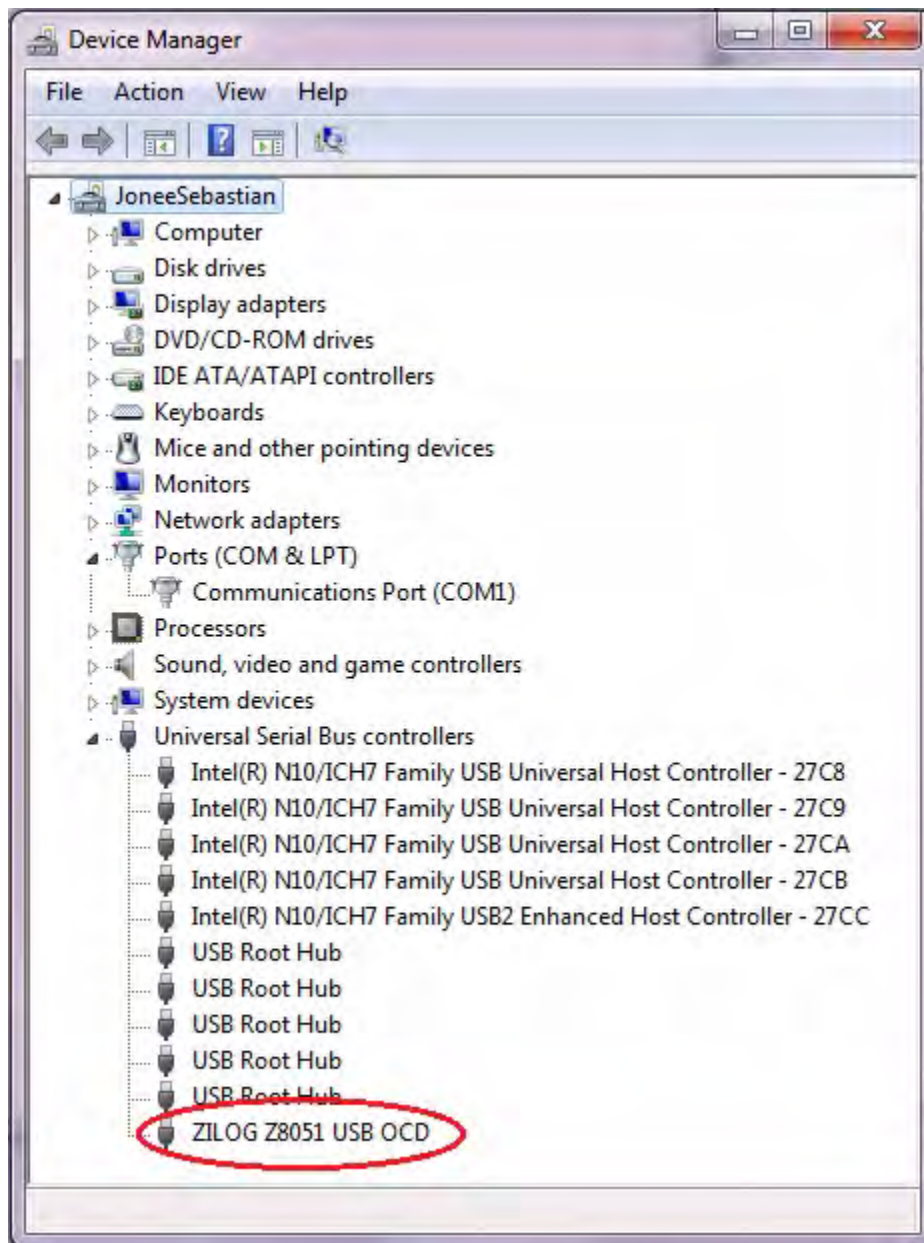

Figure 11. Device Manager Dialog, Windows 7

## FTDI USB-to-UART Driver Installation

An FTDI USB-to-UART driver is required to allow your PC to communicate through its USB port to the on-chip UART of the Z51F3220 MCU. Observe the following procedure to perform these connections.

1. Ensure that the USB cable is not plugged in to the Z51F3220 Development Board's P1 connector.
2. Navigate to the following filepath and double-click the `CDM20802_setup.exe` file to begin the driver installation.

```
<Z8051 Installation>\Z8051_<version_number>\device drivers\FTDI Uart
```

3. The installation process will begin and you should observe output similar to the following messages on the screen of your PC:

```
32-bit OS detected  
<installation path>\dpinstx86.exe  
Installation driver  
FTDI CDM driver installation process completed.
```

---

► **Note:** The above message may appear for a short time, but will then disappear from your window. This occurrence is normal.

---

4. When the installation is complete, plug in the Mini-B connector of the second USB cable into the Board, and the larger A connector into the USB port of your PC. Refer to [Figure 15](#) on page 19 for guidance.
5. If the driver installation was successful, the *Ports (COM & LPT)* section of the Device Manager will display *USB Serial Port (COMx)* or similar message, as highlighted in [Figure 12](#).



Figure 12. A Successful USB-to-UART Driver Installation

---

► **Note:** To launch the Device Manager on Windows 7 systems, launch the Start menu, enter *device manager* in the **Search programs and files** field, and press the Enter key.

To open the Device manager on earlier Windows systems, navigate via the following path:

Start → Control Panel → System → Hardware → Device Manager → Ports (COM& LPT)

---

# Configure the Z8051 OCD and Z51F3220 Development Board

Observe the following procedure to set up and configure the Z8051 On-Chip Debugger and the Z51F3220 Board.

---

**Caution:** Steps number 1 to 4 present the power-up sequence. Carefully follow these steps to avoid encountering an improper connection or disconnection.

---

1. Connect the Z8051 On-Chip Debugger (OCD) to the host PC's USB port.
2. Connect one end of the 10-circuit cable to the Z8051 OCD.
3. Connect the other end of the 10-circuit cable connector to the Z51F3220 Board's J1 connector. Pin 1 of the cable connector is indicated by a red stripe, as shown in Figure 13.

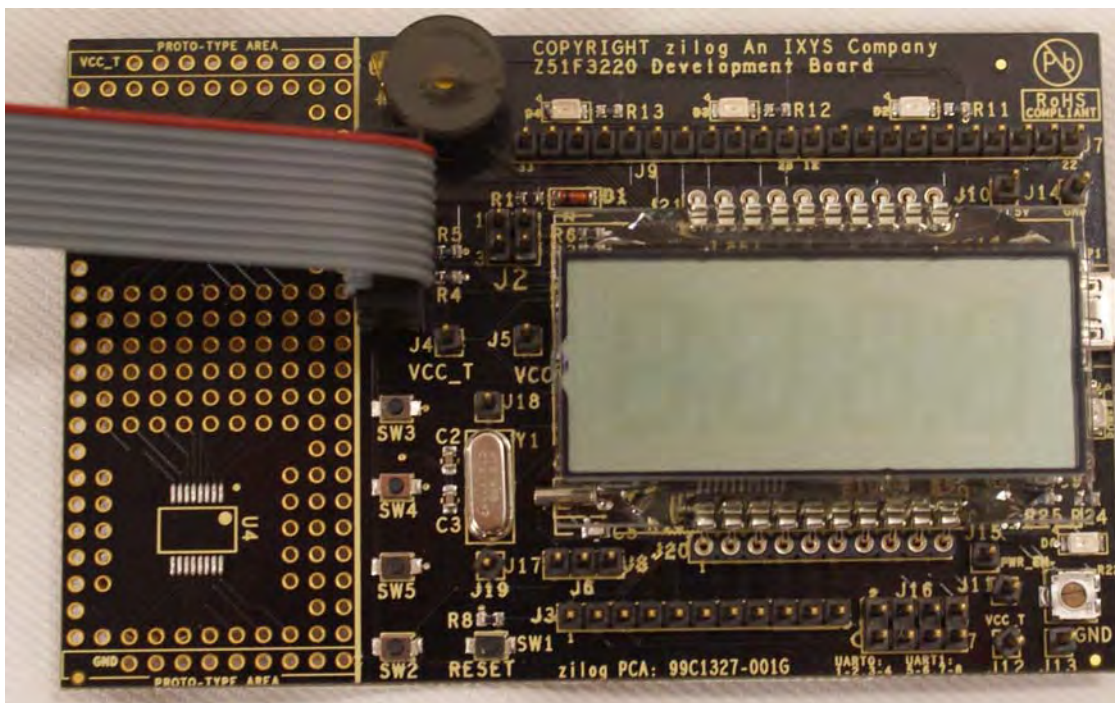

Figure 13. Connecting the 10-Circuit Cable to the Board



4. Using the second USB-to-Mini-B cable, connect the standard USB end to the host PC's USB port.
5. Connect the other end of this second Mini-B cable to the Z51F3220 Board's P1 connector to apply power to the Board. Note that the green LED D5 is ON; see Figure 14.

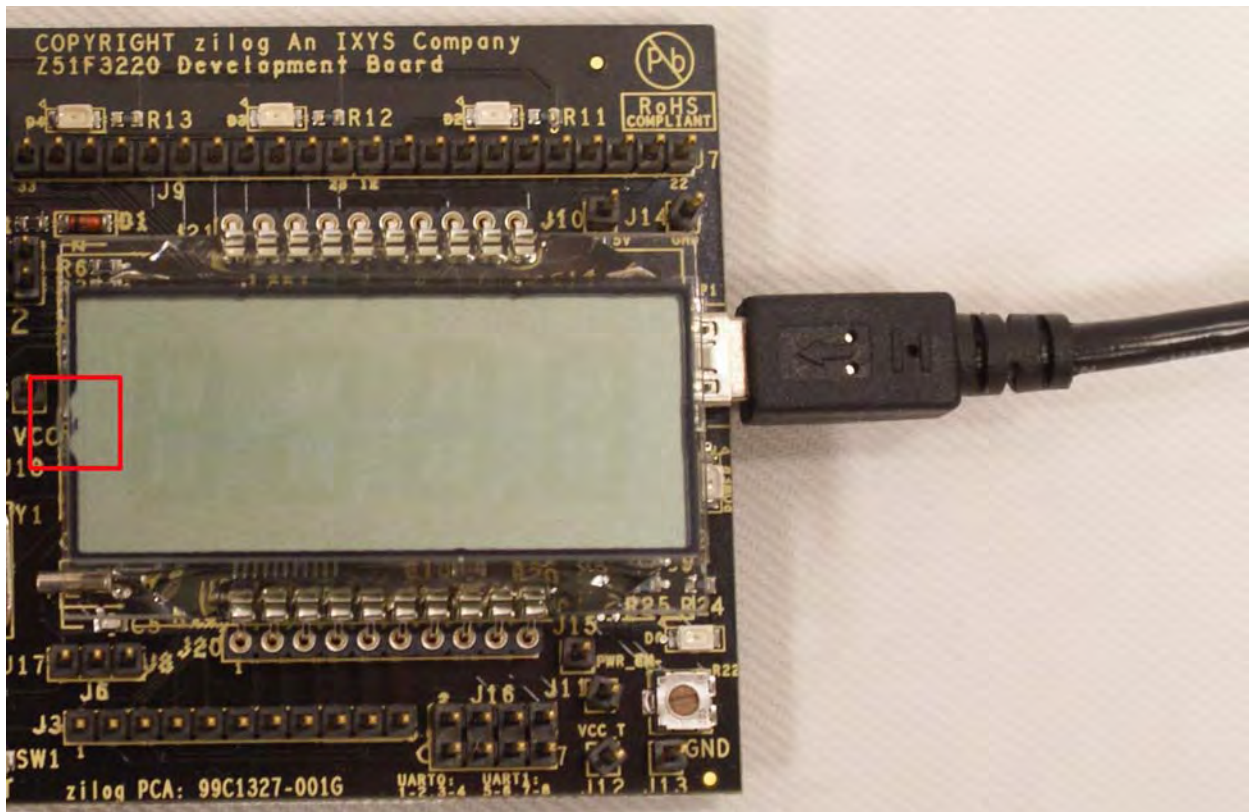

Figure 14. Connecting the USB Mini-B Cable to the Board

► **Note:** In the event that you later remove the LCD panel from the Board, observe its orientation in Figure 14. The panel's small plastic notch should be located in the position indicated by the red square.

Figure 15 shows an example of a completed hardware and software setup.

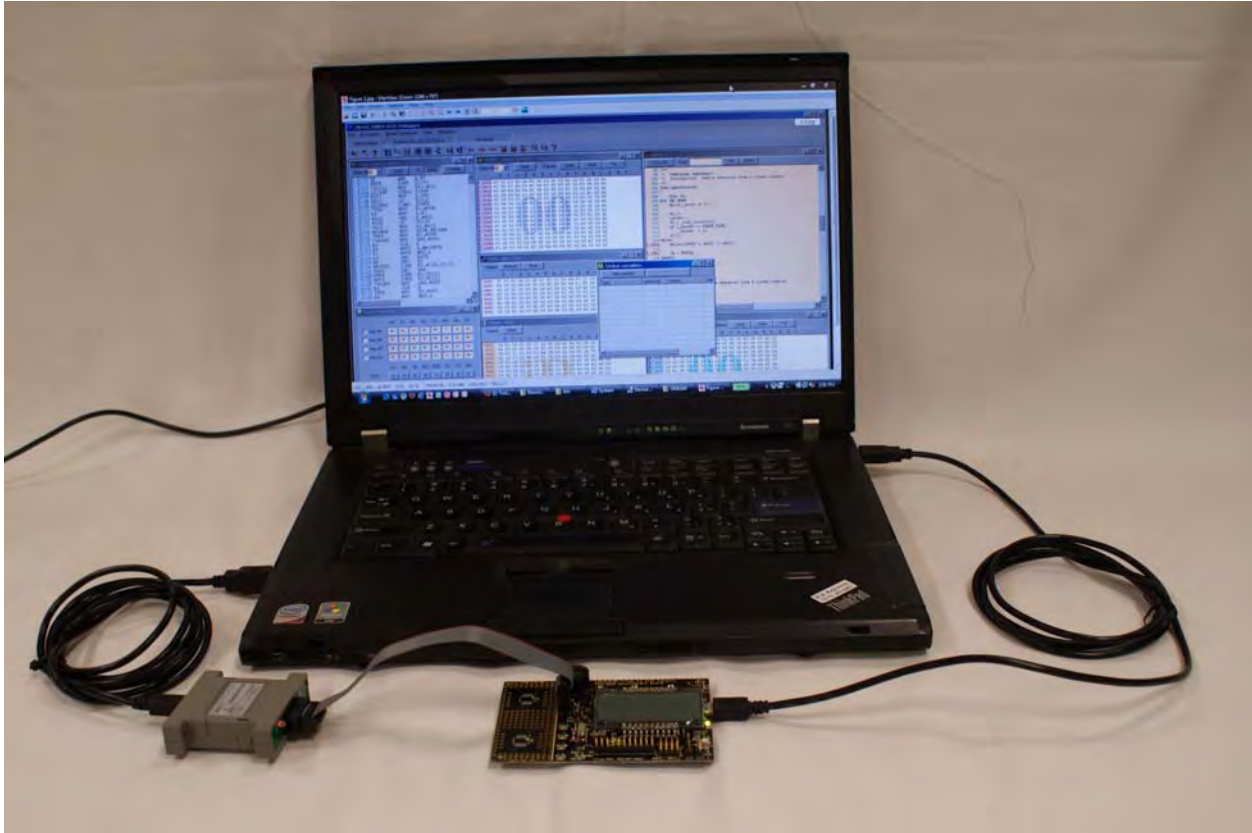

Figure 15. An Example Setup

# Build and Run the Z51F3220 Demo Project

Observe the following procedure to build and run the Z51F3220 demo project.

---

► **Note:** If you plan to use the Keil  $\mu$  Vision IDE, please skip to the the [Using the Keil  \$\mu\$  Vision IDE on a Demo Project](#) section on page 26.

---

1. Browse to the following location and double-click the `build_sdcc.bat` batch file to build the project:

<Z8051 Installation>\Z8051\_<version\_number>\samples\Z51F3220\Demo\build\_sdcc.bat

---

► **Note:** Refer to the [Z8051 Tools Product User Guide \(PUG0033\)](#) for additional information about these project files and Small Device C Compiler (SDCC) development tools.

---

2. When the build is complete, the command window will prompt the user to press any key to continue. Proceed by pressing any key on your keyboard; as a result, a hex file for the demo will be created in the following path:

<Z8051 Installation>\Z8051\_<version\_number>\samples\Z51F3220\Demo\demo.hex

3. Set up the OCD and Development Board. If you have not already configured these items, please return to the [Configure the Z8051 OCD and Z51F3220 Development Board](#) section on page 17.
4. Run the Z8051 OCD software. From the **Start** menu, navigate to **All Programs** → **Zilog Z8051 Software and Documentation <version\_number>** → **Zilog Z8051 OCD <version\_number>**. Once launched, the program will display *Connected*, as shown in Figure 16.

---

► **Note:** If you encounter a message that says *Disconnected*, return to the [Configure the Z8051 OCD and Z51F3220 Development Board](#) section on page 17 to configure the proper power-up sequence. If the problem persists, Zilog recommends that you review the [Z8051 OCD Driver Installation](#) and [FTDI USB-to-UART Driver Installation](#) sections.

---



Figure 16. Initial OCD Screen

---

► **Note:** For a free download of the latest version of the OCD software, visit [the Zilog website](#) and navigate via the **Tools and Software** menu to **Software Downloads**.

---

5. In the Debugger window, select **Load Hex** from the **File** menu to display the Object File dialog, which is shown in Figure 17.

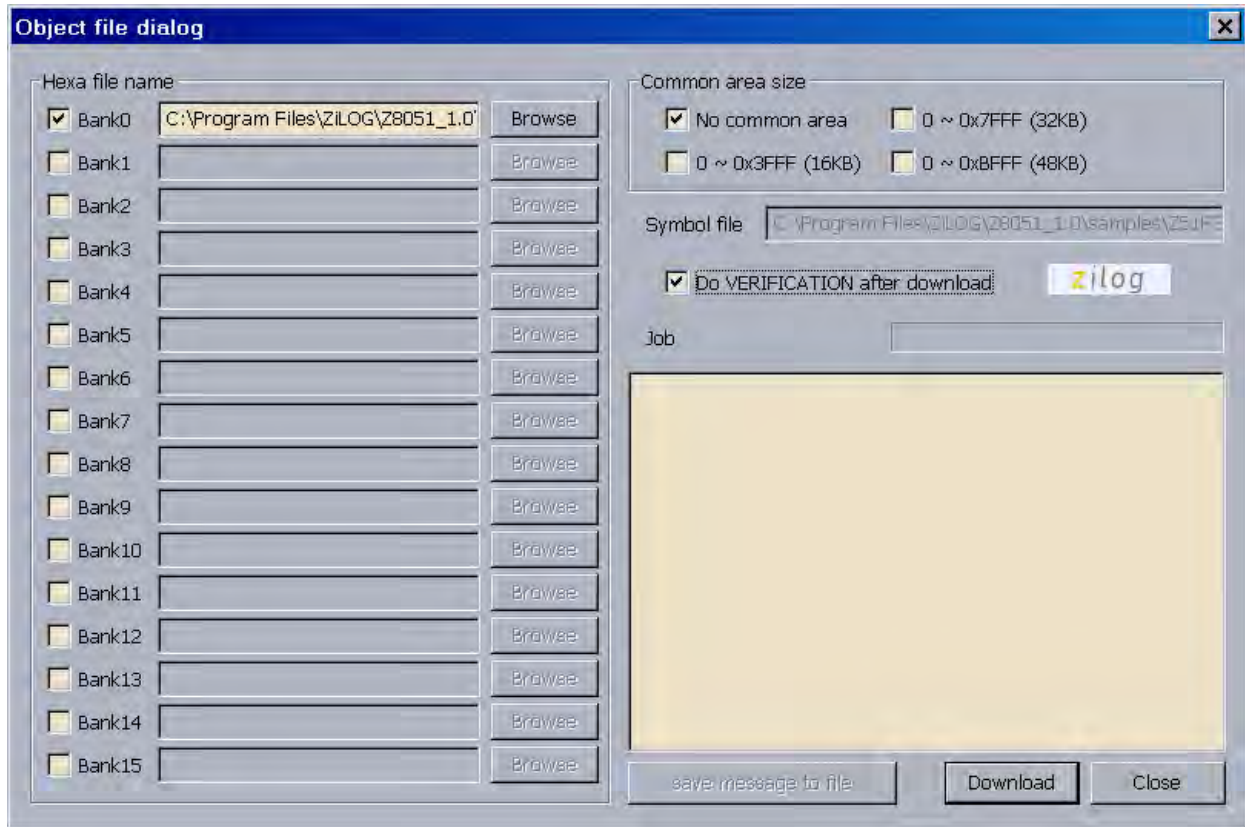

Figure 17. Object File Dialog

6. In the Object File dialog, browse to the hex file that you created in [Step 2](#) and click **Open**.
7. Click the **Download** button to open the Configuration dialog box, shown in Figure 18.

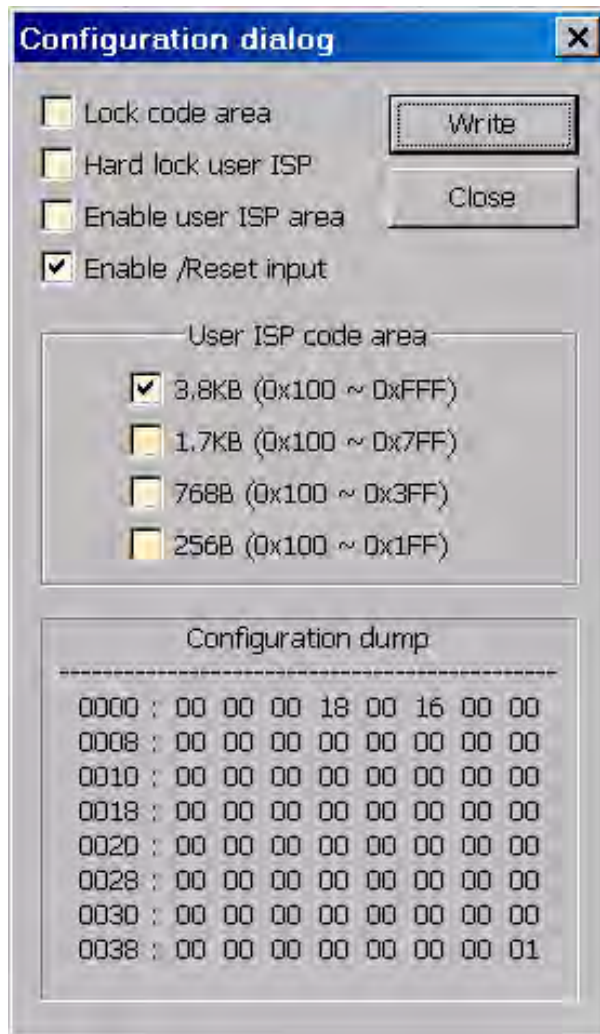

Figure 18. Configuration Dialog

8. Select **Enable/Reset input** and click the **Write** button to open the Configuration Is Changed dialog. A typical OCD display, if child windows are open, is shown in Figure 19.

---

► **Note:** Please disregard the instructions stated in the Configuration Is Changed dialog, and proceed to [Step 9](#).

---

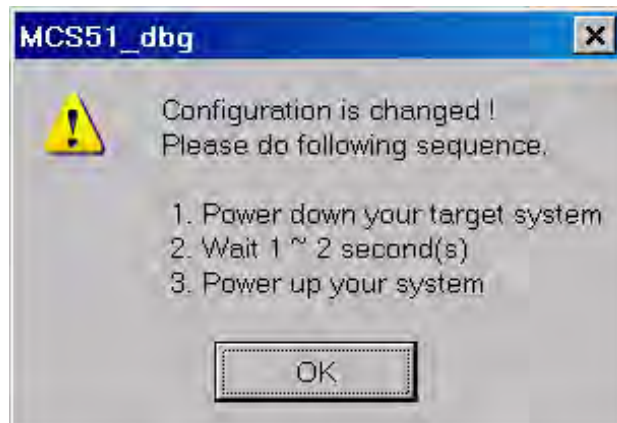

Figure 19. Configuration Is Changed Dialog

9. Click **OK** to open the On-Chip Debugger's main window. A typical OCD display is shown in Figure 20; Figure 21 shows an OCD window with child windows open.

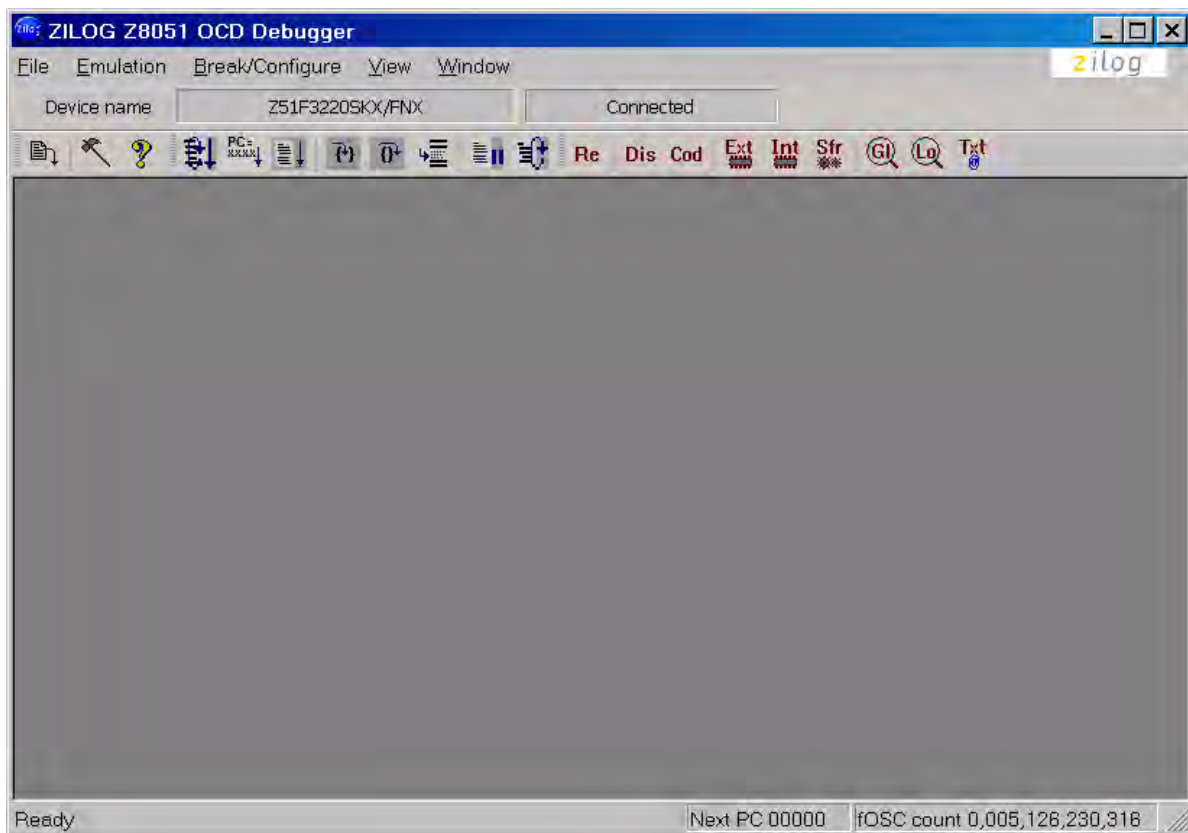

Figure 20. A Typical On-Chip Debugger Window

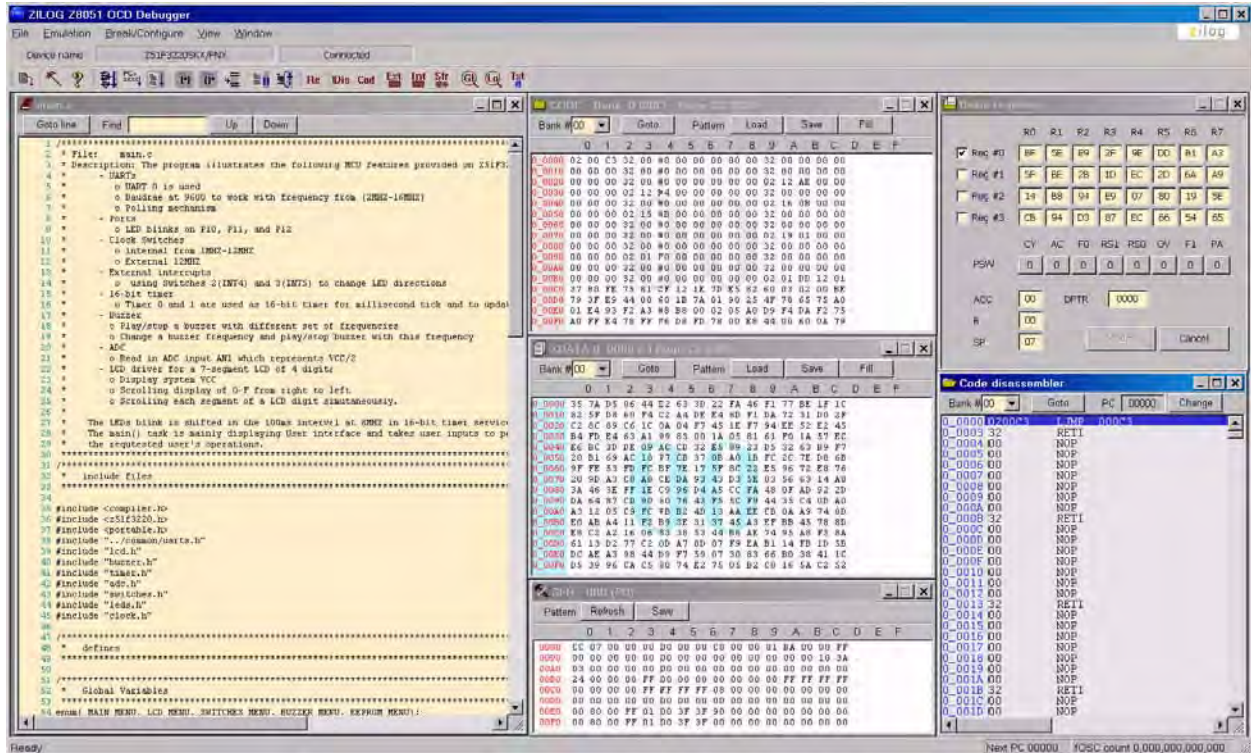

Figure 21. A Typical On-Chip Debugger Window with Child Windows Open

► **Note:** Use the View menu to open the child windows. For this demonstration, the example windows shown in Figure 21 do not need to be opened.

- Click the **Reset & Go** toolbar icon, shown in Figure 22. As a result, LEDs D2, D3 and D4 on the Z51F3220 Board will blink in sequence and the LCD panel will display the current voltage applied to the Board.



Figure 22. Reset & Go Toolbar Icon



---

► **Note:** Similar projects that you can use as references are listed in [Table 3](#) on page 36.

---

## Using the Keil $\mu$ Vision IDE on a Demo Project

Zilog's On-Chip Debugger hardware now fully supports the Keil  $\mu$ Vision IDE. Our target driver is seamlessly integrated with the Keil debugger, allowing Keil C51 users to work within the  $\mu$ Vision4 environment without switching between the Keil compiler and Zilog's external OCD software. In the demo project example that follows, the Z51F3220 MCU-related project is referenced as `Demo`.

---

► **Notes:** This document refers to the Keil  $\mu$ Vision IDE V4.53.0.6 (PK51 Prof. Developers Kit) or later.

Refer to the [Z8051 Tools Product User Guide \(PUG0033\)](#) for additional information about these project files and debugging with the Keil  $\mu$ Vision IDE and Zilog On-Chip Debugger.

---

### Debugger Configuration

Observe the following procedure to build and run a Z51F3220 demonstration project using the Keil  $\mu$ Vision IDE.

1. Start the Keil  $\mu$ Vision4 IDE.
2. From the **Project** menu, select **Open Project** and navigate to the following filepath:  
<Installation directory>\Z8051\_<version>\samples\Z51F3220\Demo
3. Select the `Demo.uvproj` file and click **Open**; see Figure 23.

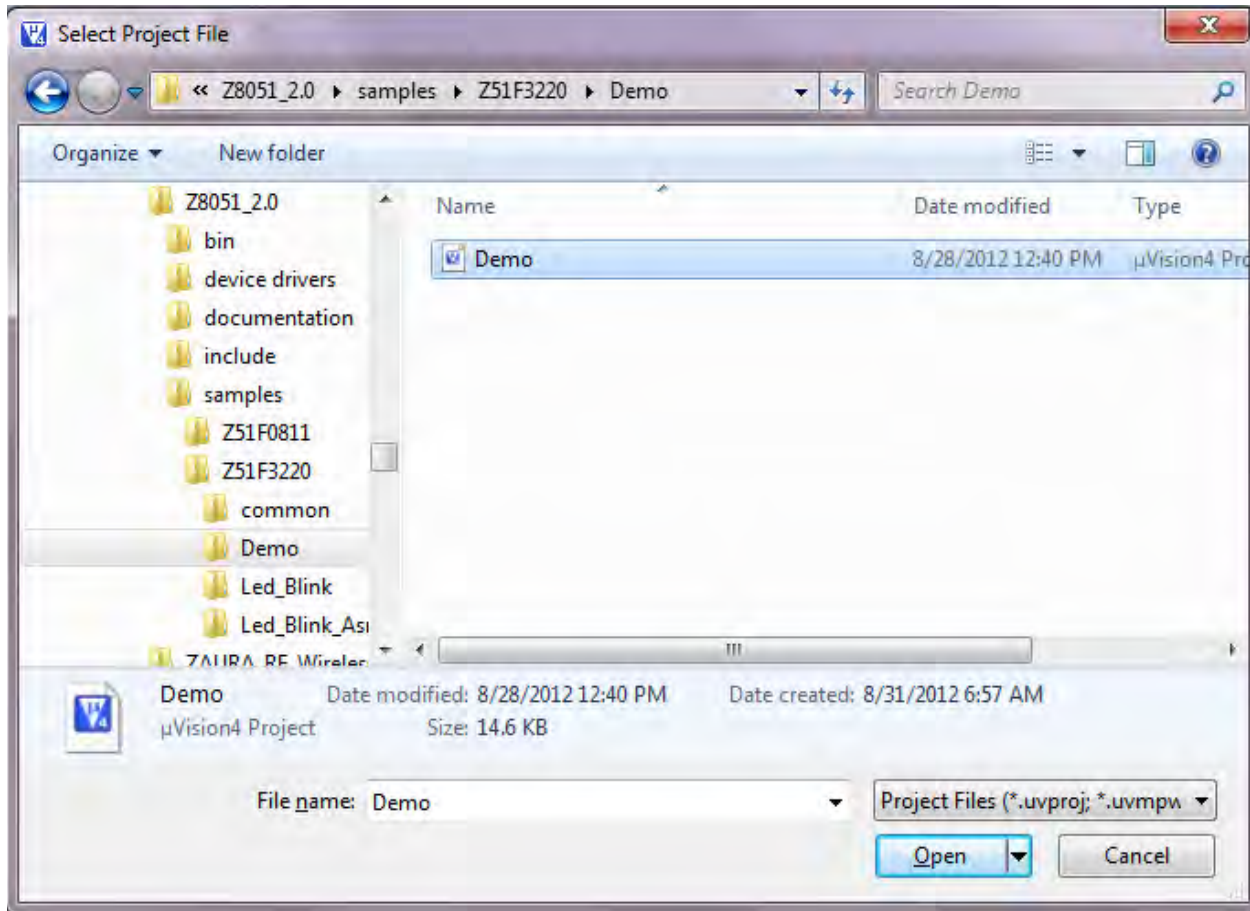

Figure 23. Selecting the Demo Project File

4. Return to the **Project** menu and select **Options for Target 'Demo'**.
5. In the Options for Target 'Demo' dialog that appears, click the **Device** tab and ensure that your target is properly selected for your project, as illustrated in Figure 24.

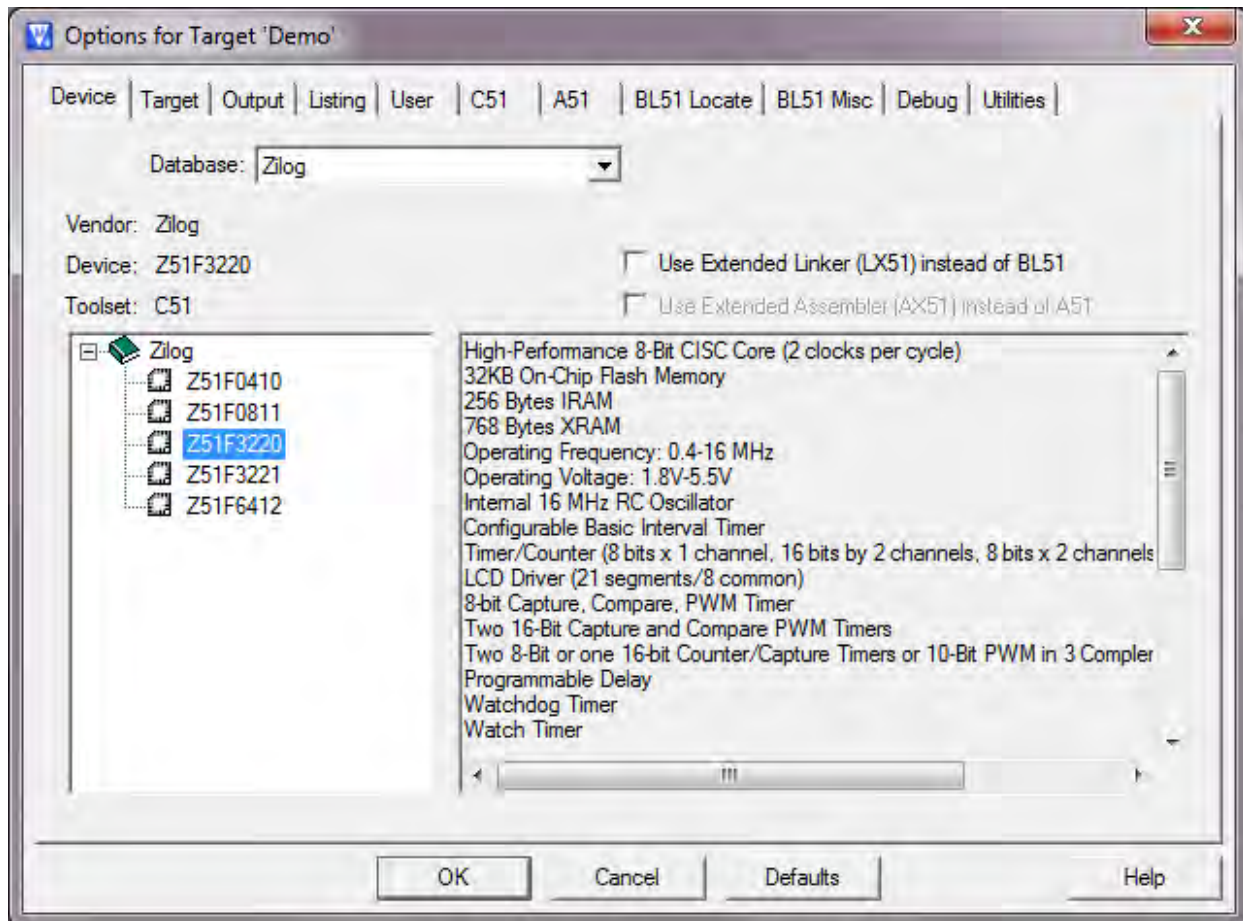

Figure 24. Selecting the Target

6. After selecting the target, click the **Debug** tab and select the **Zilog Z8051 Target Driver** from the **Use:** drop-down menu, as highlighted in Figure 25.

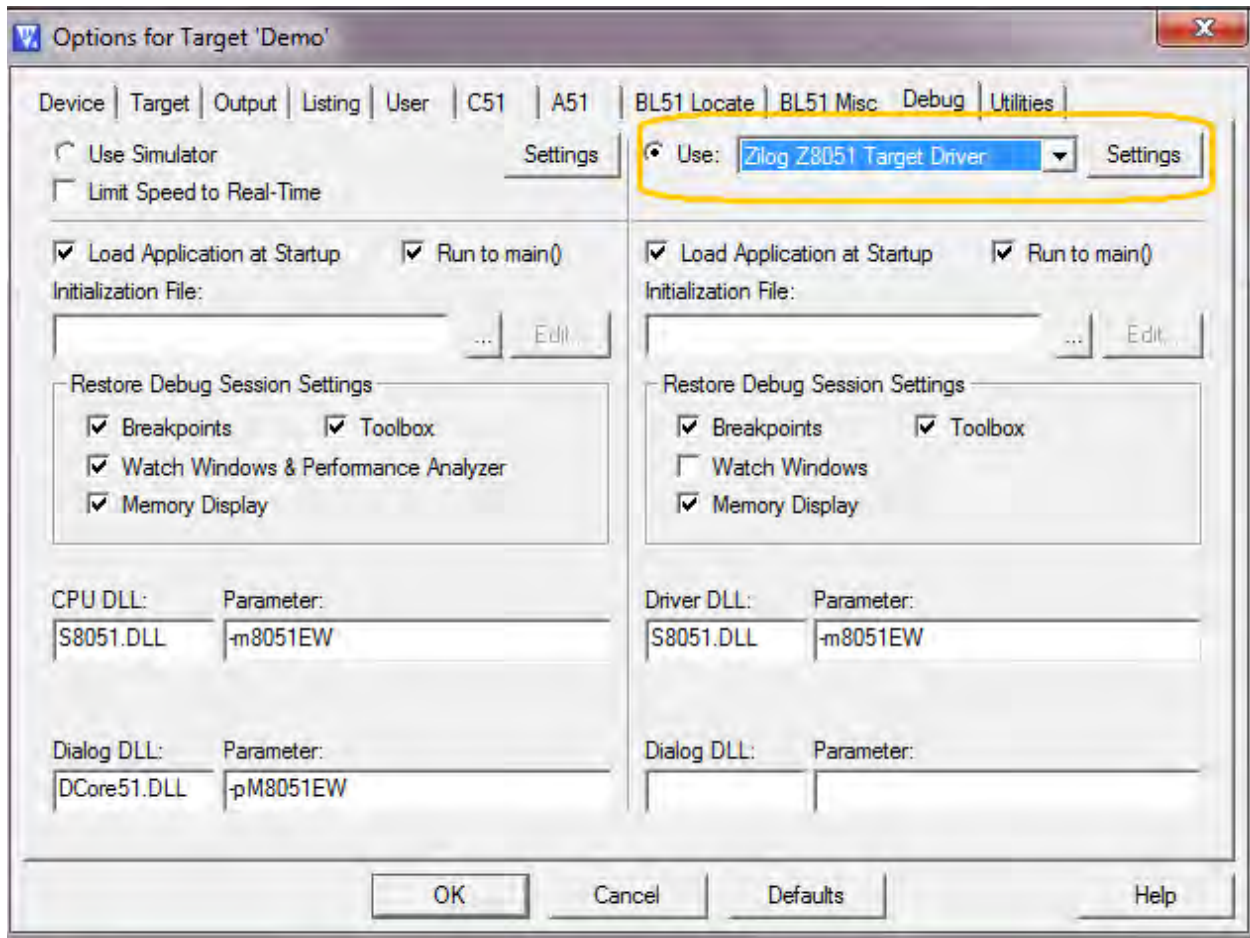

Figure 25. Selecting the Target Driver

7. Click the **Settings** button, located to the right of this drop-down menu, to configure your Debug and Flash options. The Settings dialog is displayed with the Debug Options tab appearing by default, as shown in Figure 26.

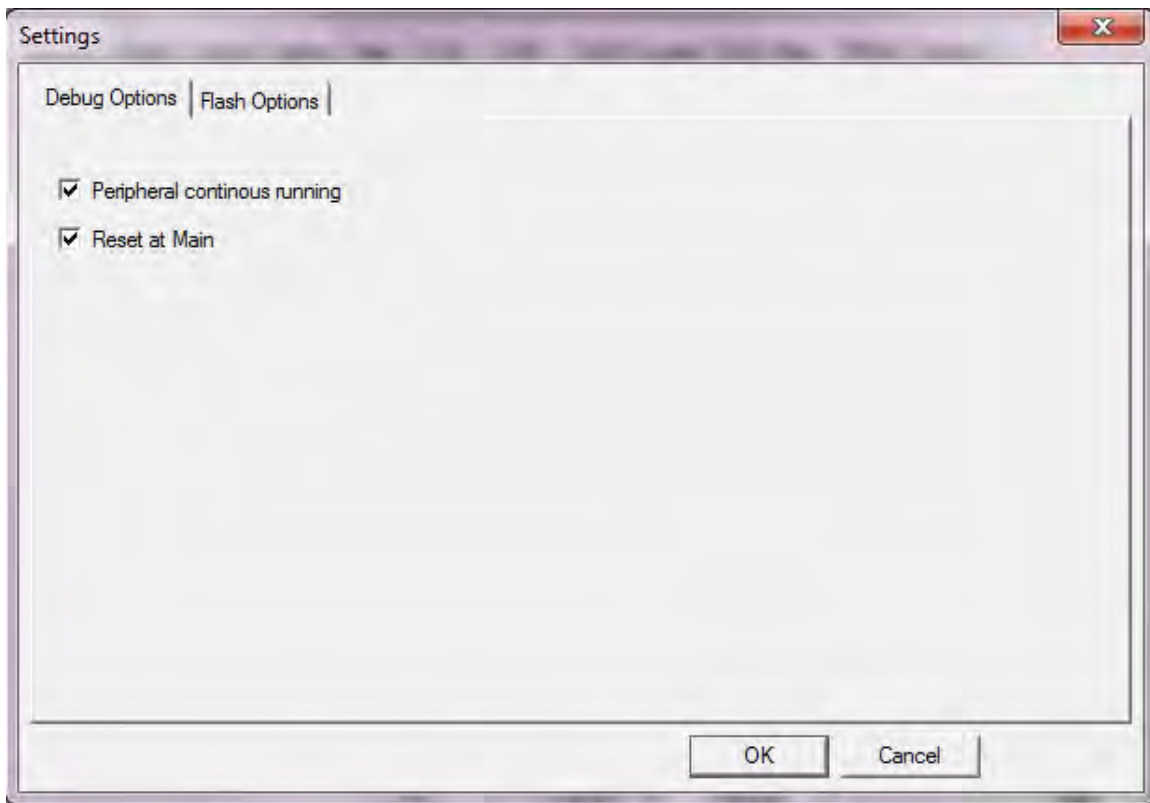

Figure 26. Configuring the Debug Options

- 
- **Notes:** When configuring the appropriate Debug option, be aware of the following stipulations:
- Checking the **Peripheral continues running** option means that the timers used in your project will run while the processor is stopped by the debugger.
  - The **Reset at Main** option will only work if you have a main file in your project; otherwise you should deselect this option.

- 
8. Click the **Flash Options** tab. The Flash Options Settings dialog will appear, as shown in Figure 27. To select the proper options for Flash programming, refer to the [Z51F3220 Product Specification \(PS0299\)](#).

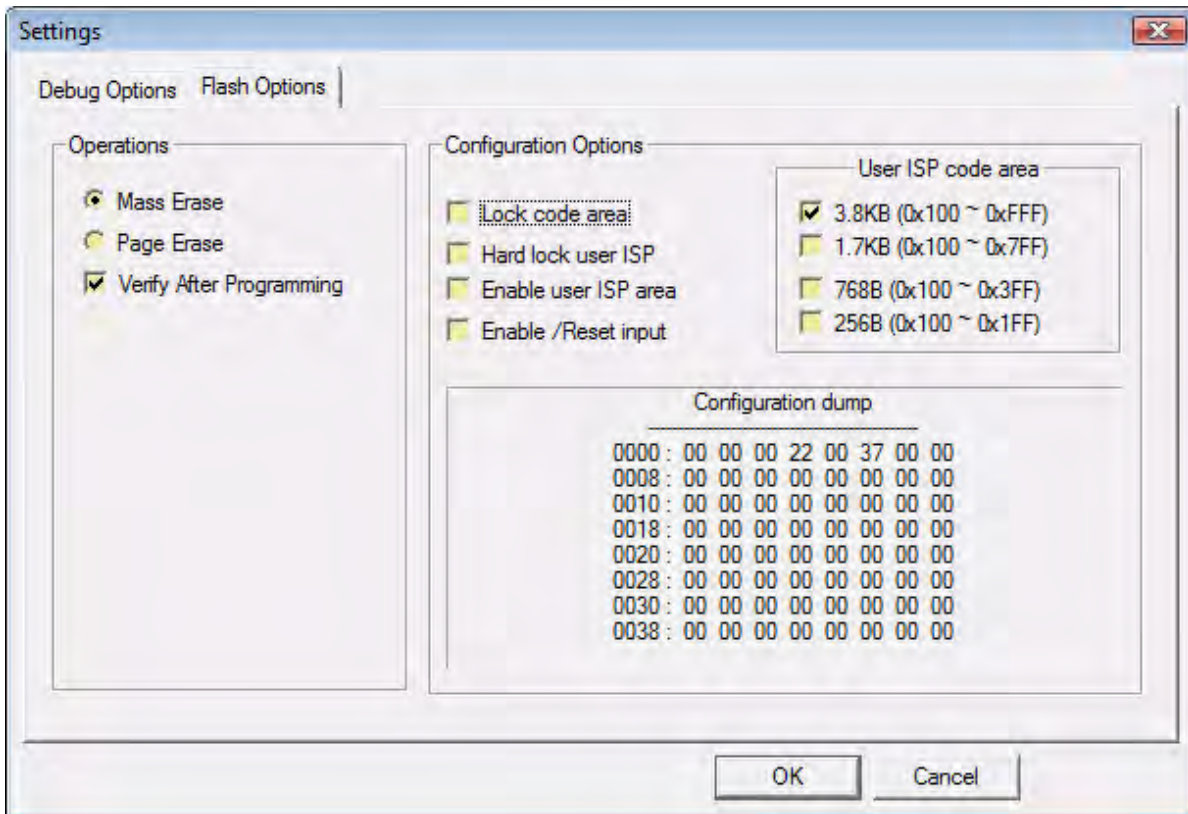

Figure 27. Configuring the Flash Options

9. Click **OK** to exit the Settings dialog.
10. From the **Options for Target 'Demo'** dialog, select the **Load Application at Startup** checkbox, as shown in Figure 28, the so that the IDE will download the code upon connection. There is no need to select or enter an initialization file.

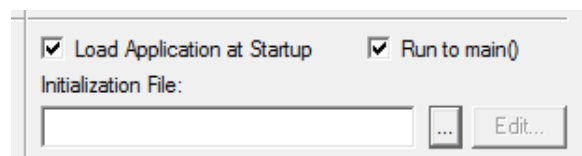

Figure 28. Load Application at Startup Settings

11. Click **OK** to exit the **Options for Target 'Demo'** dialog.
12. From the **Project** menu, select **Rebuild All** to rebuild all target files.

13. Start your debugging session by clicking the **Start/Stop Debug Session** icon, as indicated in Figure 29. A default Windows configuration of the debug session is shown in Figure 30.

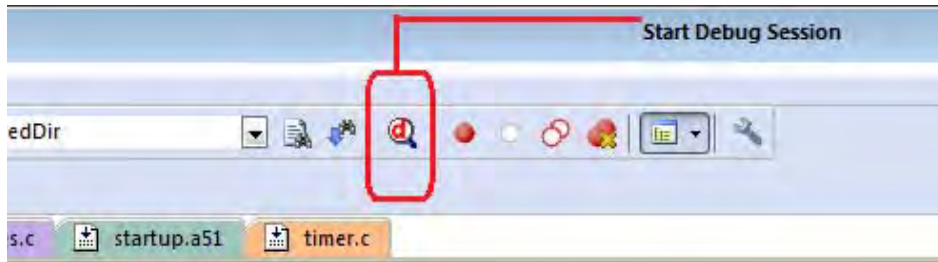

Figure 29. Beginning a Debug Session

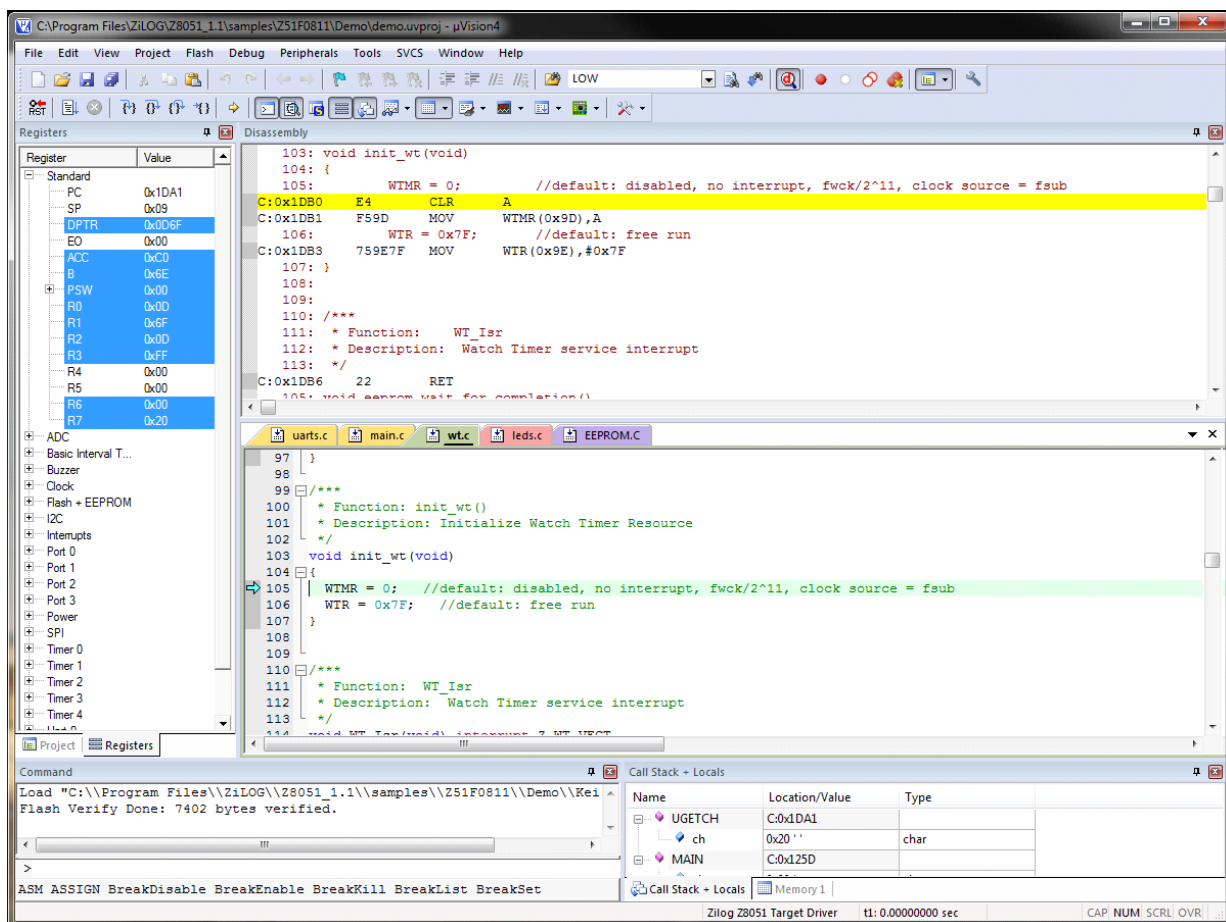

Figure 30. A Default Debug Session

---

► **Note:** The following buttons in the Keil  $\mu$  Vision IDE are not supported by the Zilog OCD driver:



To learn more about the full functionality of the Keil  $\mu$  Vision IDE, please refer to the Keil Keil  $\mu$  Vision4 IDE documentation.

- 
14. From the **Debug** menu, select **Run**, or simply press the **F5** key on your Windows keyboard to run the demo project. As a result, LEDs D1, D2 and D3 on the Z51F3220 Evaluation Board will blink in sequence.
  15. To stop code execution, select **Stop** from the **Debug** menu.
  16. To stop your debugging session, click the **Start/Stop Debug Session** icon.

---

► **Note:** Refer to [Appendix C](#) on page 45 for a discussion of Stand-Alone Flash Programming Using the Keil  $\mu$  Vision IDE.

---

## HyperTerminal Configuration

A communications program such as HyperTerminal can be used on Windows XP systems to view the messages from the Z51F3220 Development Board. The following procedure examines how to configure HyperTerminal for the Z51F3220 demo project.

---

► **Note:** The HyperTerminal application is not available in Windows Vista and Windows 7 systems. If you are using either of these operating systems, consider using/installing different communication software, such as Tera Term. Please refer to the documentation for the particular emulation software you use to configure it for communication with the Z51F3220 Development Board.

---

1. In HyperTerminal, select the COM port assigned to the USB-to-UART interface cable that is connected to the P1 connector on the Development Board.



► **Note:** This COM port can be determined from the Device Manager, as described in the the [FTDI USB-to-UART Driver Installation](#) section on page 15.

2. Configure this port to reflect the following settings:
  - 9600bps
  - 8 data bits
  - No parity
  - 1 stop bit
  - No flow control
  
3. Click the **Call** button to connect to the Z51F3220 Board. Upon connection, you should be able to see the Demo program menu shown in Figure 31.

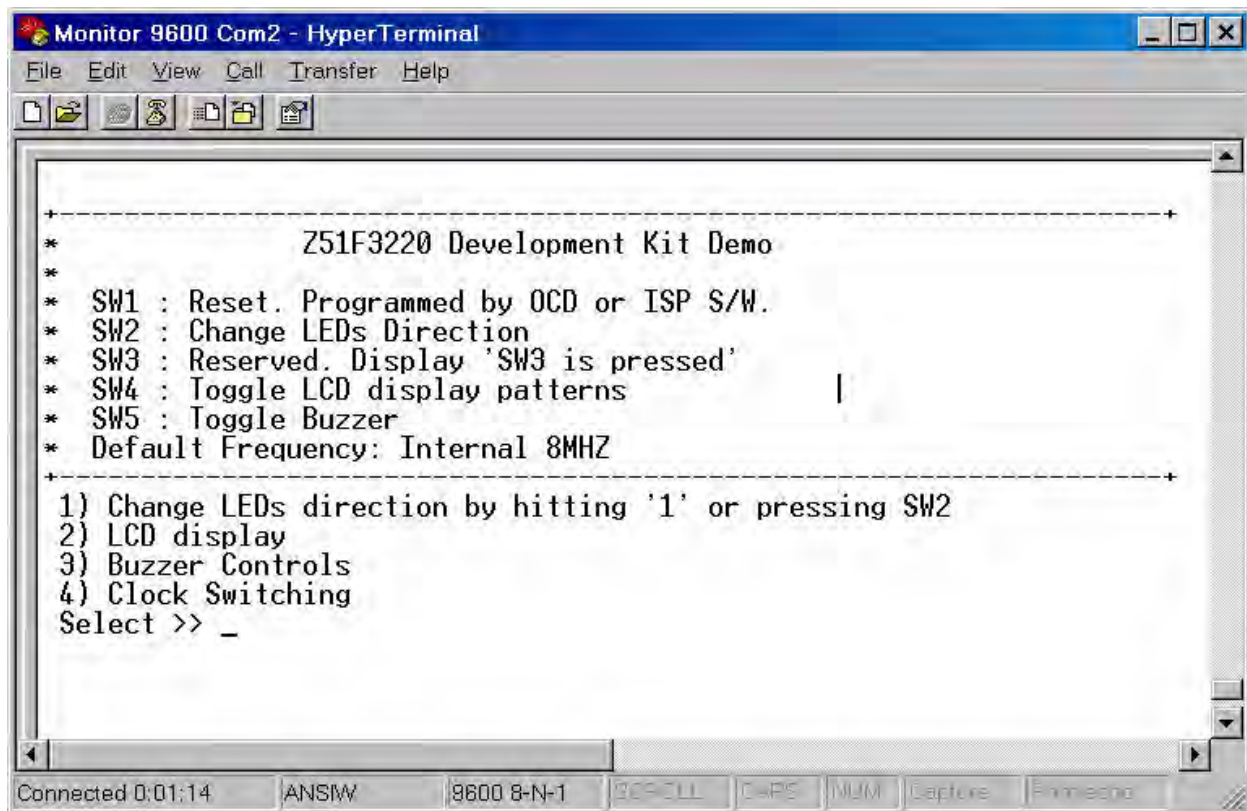

Figure 31. Demo Program Menu in HyperTerminal

At this point, you have successfully run the Z51F3220 demo project, but you are welcome to continue evaluating the demo in HyperTerminal. For additional information about how to create, edit, run and debug this project, please see the [Z8051 Tools Product User Guide \(PUG0033\)](#) and/or the [Z8051 On-Chip Debugger and In-System Programmer User Manual \(UM0240\)](#).

---

► **Note:** Turn off the power by removing the USB cable from the P1 connector on the Development Board.

---

# Sample Projects and Documentation

A number of sample projects are included on the CD that ships with the Z51F3220 Development Kit, and their locations, listed in Table 3, will be accessible upon installation.

**Table 3. Z51F3220 Development Kit Sample Projects**

Description	Location
Demo	samples\Z51F3220\Demo
Led Blink	samples\Z51F3220\Led_Blink samples\Z51F3220\Led_Blink_Asm

A number of Z8051-related documents are included in the Z51F3220 Development Kit, and their locations, listed in Table 4, will be accessible upon installation. You can also find current versions of each of these documents on the [Zilog website](#).

**Table 4. Z51F3220 Development Kit Documentation**

Description	Document	Location
Z51F0410 Product Specification	PS0295	Documentation\Chip_Documentation
Z51F0811 Product Specification	PS0296	Documentation\Chip_Documentation
Z51F3220 Product Specification	PS0299	Documentation\Chip_Documentation
Z51F3221 Product Specification	PS0300	Documentation\Chip_Documentation
Z51F6412 Product Specification	PS0303	Documentation\Chip_Documentation
Z51F0410 Product Brief	PB0237	Documentation\Chip_Documentation
Z51F3220 Product Brief	PB0238	Documentation\Chip_Documentation
Z51F3220 Product Brief	PB0239	Documentation\Chip_Documentation
Z51F3221 Product Brief	PB0240	Documentation\Chip_Documentation
Z51F6412 Product Brief	PB0241	Documentation\Chip_Documentation
Z8051 OCD and ISP User Manual	UM0240	Documentation\Tools_Documentation
Z51F0811 Evaluation Kit User Manual	UM0242	Documentation\Tools_Documentation
Z51F3220 Development Kit User Manual	UM0243	Documentation\Tools_Documentation
Z8051 Tools Product User Guide	PUG0033	Documentation\Tools_Documentation

# Schematic Diagrams

Figures 32 and 33 display schematic diagrams of the Z51F3220 Development Board.

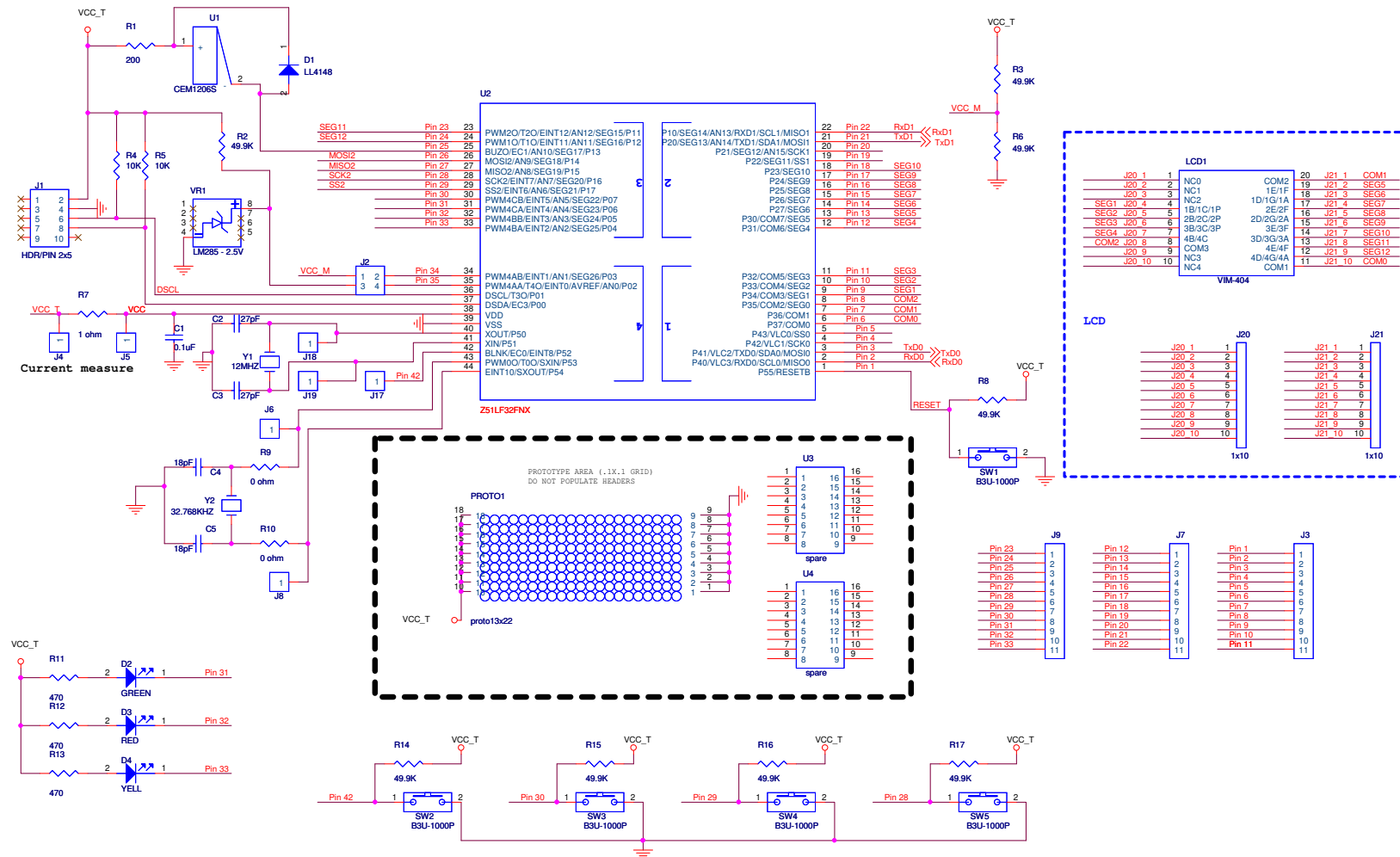

Figure 32. Z51F3220 Development Board, #1 of 2



## Appendix A. OCD Driver Installation on Windows Vista Systems

The driver programs for the Z8051 On-Chip Debugger are copied to the development PC during the software and documentation installation. In the following procedure for PCs running Windows Vista 32- and 64-bit operating systems, ensure that the target side of the OCD will remain unconnected while you install these drivers.

1. Connect the OCD hardware to the USB port of your PC by connecting the A (male) end of one of the two USB A (male)-to-Mini-B cables with the development PC's USB port. Connect the Mini-B end to the OCD device.
2. After the PC detects the new hardware, it will display the Found New Hardware Wizard dialog box, shown in Figure 34. Click **Locate and install driver software (recommended)**.

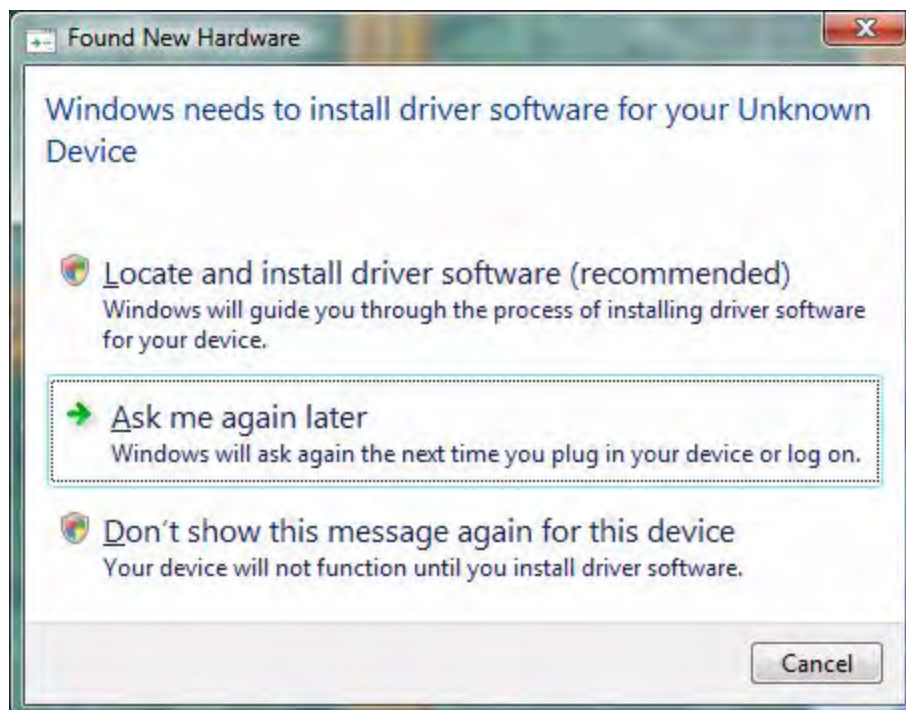

Figure 34. Found New Hardware Dialog, Windows Vista

3. Depending on your development PC's User Account Control settings, Windows may ask for permission to continue the installation. Click **Continue**.

4. When the **Insert the Disc** dialog appears, as shown in Figure 35, select **I don't have the disc. Show me other options.** Click the **Next** button to display the dialog that follows, which is shown in Figure 36.



Figure 35. Install Device Driver Dialog, Windows Vista

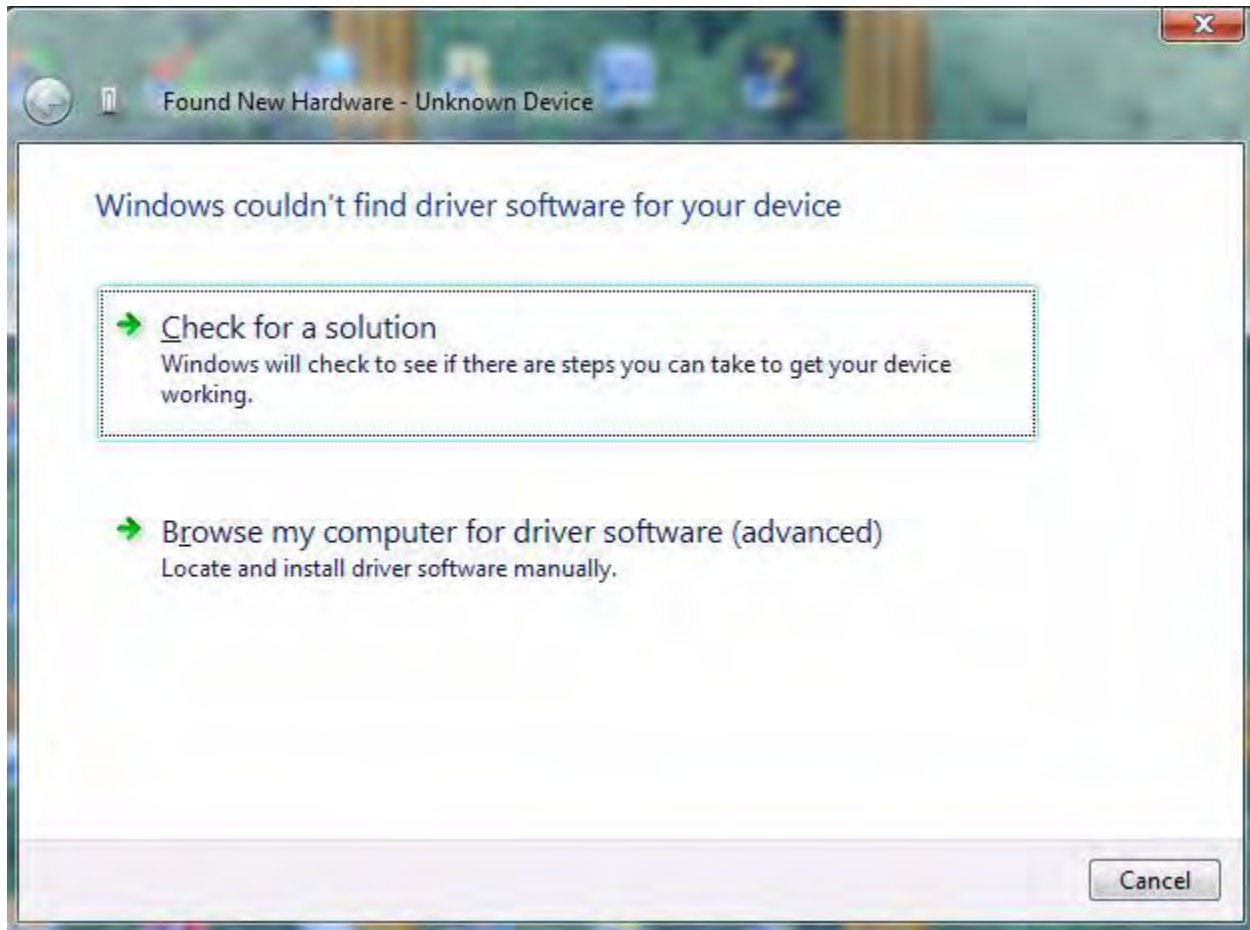

Figure 36. Couldn't Find Driver Dialog, Windows Vista

5. Return to page 8 and follow [Steps 3 through 6](#).



## Appendix B. OCD Driver Installation on Windows XP Systems

The driver programs for the Z8051 On-Chip Debugger are copied during the software and documentation installation. In the following procedure for Windows XP systems, ensure that the target side of the OCD will remain unconnected while you install these drivers.

1. Connect the OCD hardware to the USB port of your PC by connecting the A-Male end of one of the two USB A (male)-to-Mini-B cables with the host PC's USB port, and connect the Mini-B end to the OCD device.
2. After the PC detects the new hardware, it will display the **Found New Hardware Wizard** dialog box, shown in Figure 37. Select **Install from a list or specific location (Advanced)**; then click **Next**.



Figure 37. The Found New Hardware Wizard Welcome Screen

3. The next dialog box, shown in Figure 38, prompts you to enter a path or navigate to the directory in which the .inf file was installed. Depending on the type of computer you use (32-bit or 64-bit), use the **Browse** button to navigate to one of the following paths and click the **Next** button, leaving all other selections at their default settings.
  - On 32-bit machines, use the following path:  
<Z8051 Installation>\Z8051\_<version\_number>\device drivers\OCD USB\x32
  - On 64-bit machines, use the following path:  
<Z8051 Installation>\Z8051\_<version\_number>\device drivers\OCD USB\x64

---

► **Note:** On some installations, the Found New Hardware screen shown in Figure 37 may also display the text string, Zilog Z8051 USB OCD - No Firmware. This occurrence is normal and can be disregarded.

---

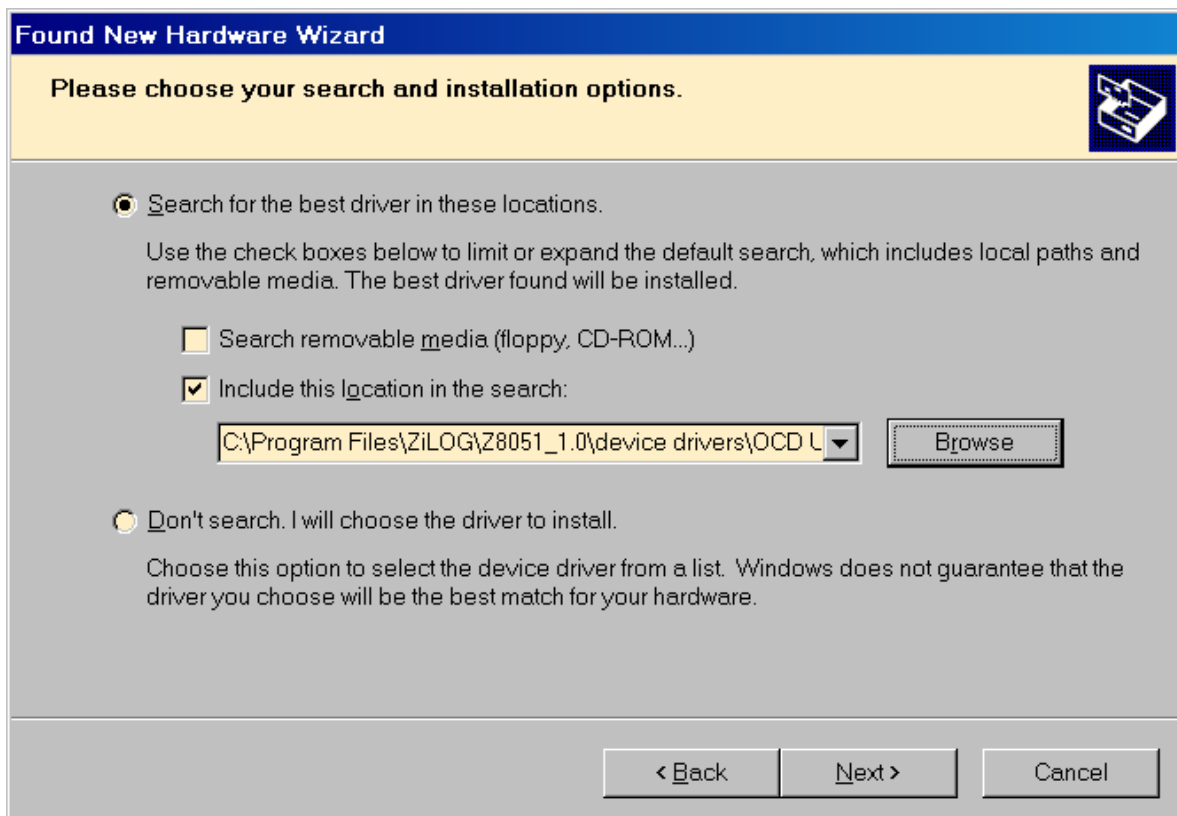

Figure 38. The Found New Hardware Wizard's Browse Screen

4. When Windows prompts you whether to continue the installation or stop, click the **Continue Anyway** button and wait until the installation is completed (Windows may prompt you more than once). When the installation is complete, click **Finish**.

## Appendix C. Stand-Alone Flash Programming Using the Keil $\mu$ Vision IDE

Observe the following procedure to program Flash memory without debugging.

1. From the **Project** menu, open the **Options for Target 'your project'**, and click the **Utilities** tab. In the **Use Target Driver for Flash Programming** drop-down menu within the Configure Flash Menu Command pane, ensure that **Zilog Z8051 Target Driver** is selected, as indicated in Figure 39.

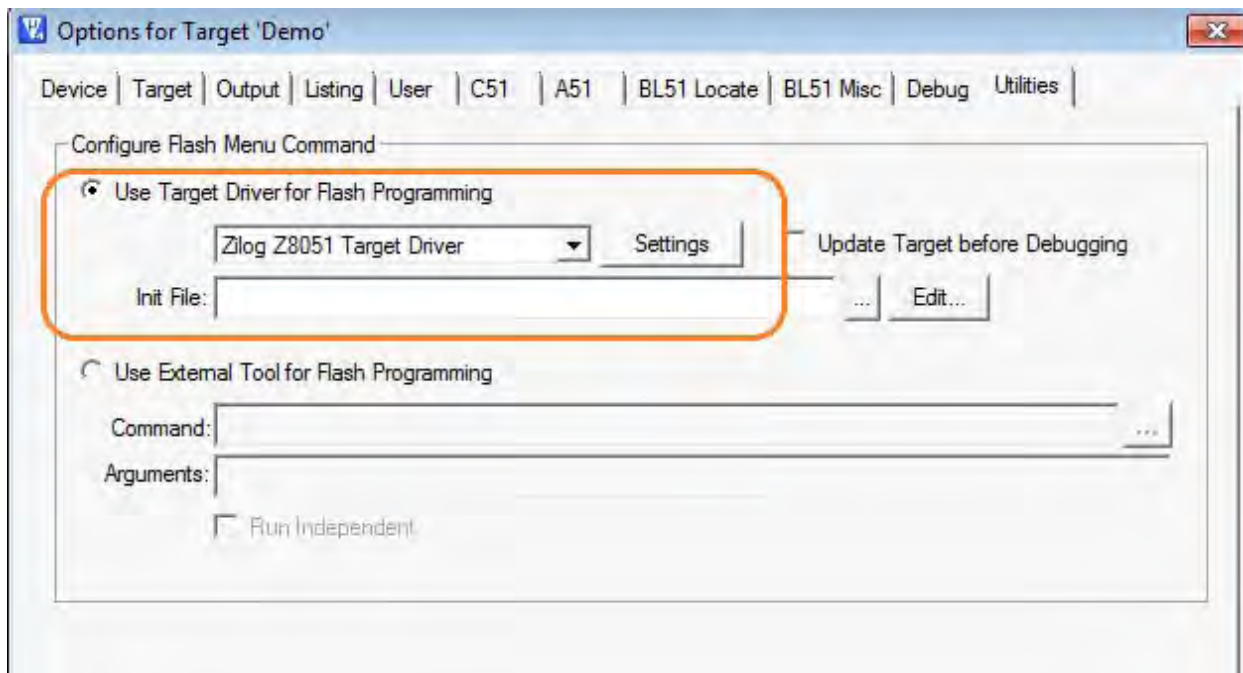

**Figure 39. Selecting A Target Driver For Flash Programming**

2. Click the **Settings** button to change any additional Flash options. The Settings dialog will appear, as shown in Figure 40.

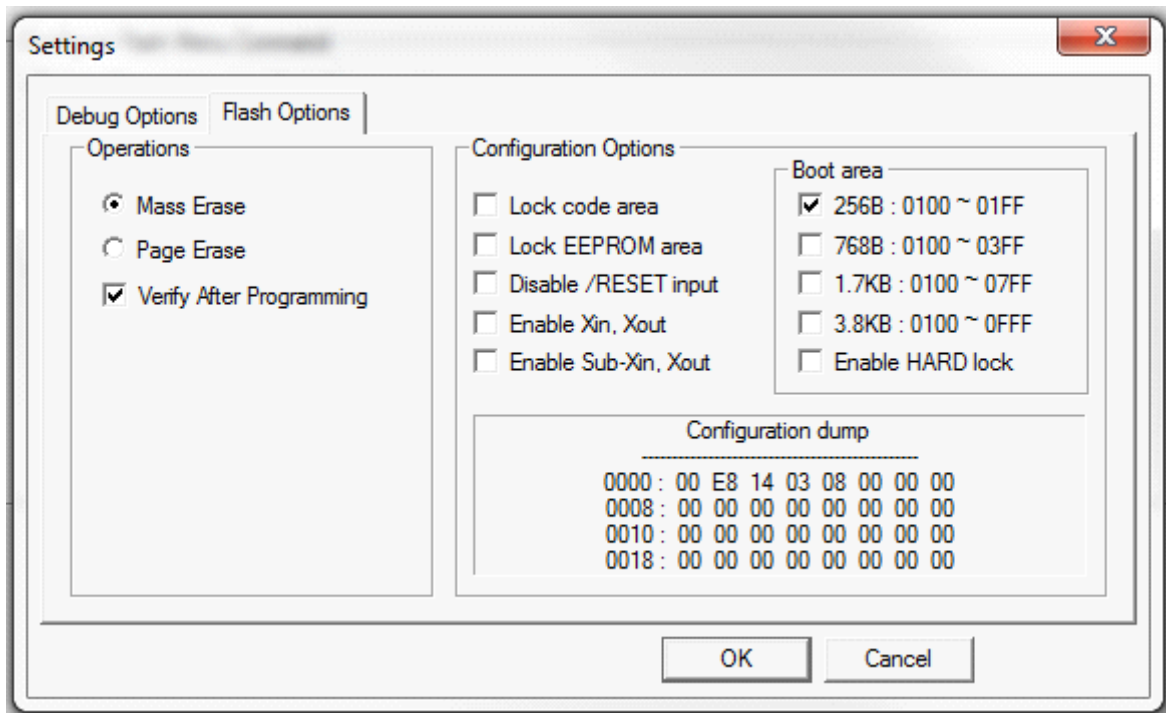

Figure 40. Configuring Additional Flash Options

3. After you have selected your Flash options, click **OK** to exit the **Flash Options** dialog.
4. Click **OK** to exit the **Options For Target 'Demo'** dialog.
5. From the **Flash** menu of the Keil IDE (see Figure 41), select either of the following options:
  - Select **Download** to program Flash memory with the current project
  - Select **Erase** to perform a mass erase of internal Flash memory

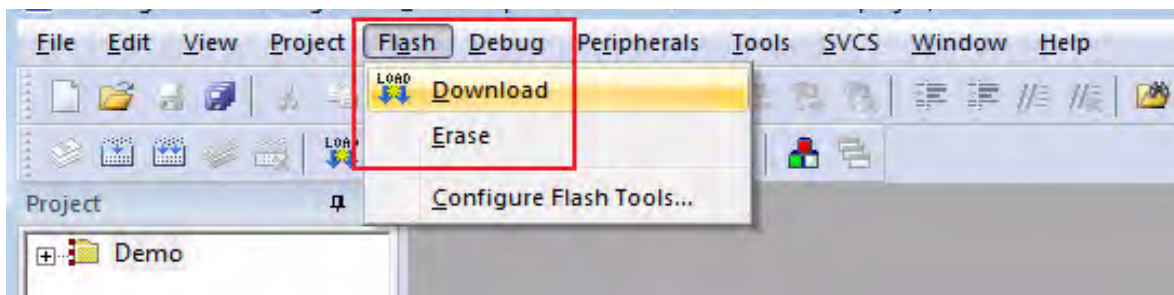

Figure 41. The Keil IDE Flash Menu

# Customer Support

To share comments, get your technical questions answered, or report issues you may be experiencing with our products, please visit Zilog's Technical Support page at <http://support.zilog.com>.

To learn more about this product, find additional documentation, or to discover other facets about Zilog product offerings, please visit the [Zilog Knowledge Base](#) or consider participating in the [Zilog Forum](#).

This publication is subject to replacement by a later edition. To determine whether a later edition exists, please visit the Zilog website at <http://www.zilog.com>.