

## High Efficiency, 36V 100mA Synchronous Step-Down Converter

### General Description

The RT6208 is a high-efficiency, monolithic synchronous step-down DC/DC converter that can deliver up to 100mA output current from a 4.75V to 36V input supply. It requires only 25µA typical supply current at no load while maintaining output voltage regulation. The RT6208 achieves Boundary Conduction Mode (BCM) operation, low quiescent current and programmable high-side peak current limit, providing high efficiency over a wide range of load currents. It also provides soft-start protection to eliminate input current surge during start-up. The low current (3µA) shutdown mode provides output disconnect, enabling easy power management in battery-powered systems. The RT6208 is available in a SOT-23-6 and SOT-23-8 packages.

### Ordering Information

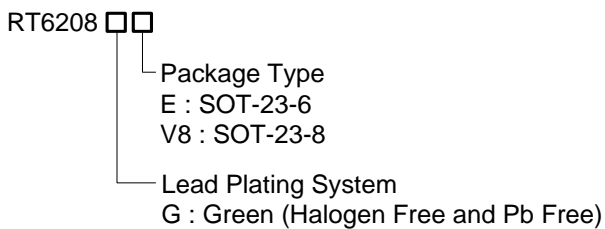

Note :

Richtek products are :

- ▶ RoHS compliant and compatible with the current requirements of IPC/JEDEC J-STD-020.
- ▶ Suitable for use in SnPb or Pb-free soldering processes

### Features

- Achieves Very High Efficiency in Low Load Conditions
- ±1% High Accuracy Feedback Voltage
- 4.75V to 36V Input Voltage Range
- 100mA Output Current
- Integrated High-Side and Low-Side Switches
- No Compensation Required
- Low Quiescent Current
- Adjustable Peak Current Limit
- Cycle-by-Cycle Over Current Protection
- Input Under Voltage Lockout
- Internal Soft-Start
- Thermal Shutdown Protection

### Applications

- Wireless Charger
- Industrial and Commercial Low Power Systems
- Green Electronics/Appliances
- Point of Load Regulation for High-Performance DSPs
- MCU Supply in Wireless LED Lighting

### Marking Information

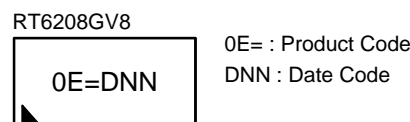

## Pin Configurations

(TOP VIEW)

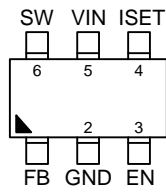

SOT-23-6

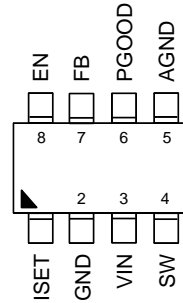

SOT-23-8

## Functional Pin Description

Pin No		Pin Name	Pin Function
SOT-23-6	SOT-23-8		
1	7	FB	Feedback Voltage Input. This pin receives the feedback voltage from a resistive divider connected across the output.
2	2	GND	Power Ground.
3	8	EN	Enable Control Input. A voltage on this pin above 1.25V enables the converter into normal mode; forcing this pin below 0.3V shuts down the IC, reducing quiescent current to 3μA. An internal 2μA current pulls up enable pin for automatic startup.
4	1	ISET	High-Side Peak Current Set Pin. A resistor from this pin to GND sets the high-side peak current limit. Leave floating for the maximum peak current, 225mA. Short this pin to GND for the minimum peak current, 50mA. A 1μA current is sourced out of this pin.
5	3	VIN	Input Supply Voltage. Must bypass with a suitably large ceramic capacitor.
6	4	SW	Switch Node. Connect The Switching Node To External Inductor.
--	6	PGOOD	Power Good Open Drain Output. Asserts low if output voltage is low due to OTP, UVP, UVLO, EN shutdown or during soft-start.
--	5	AGND	Analog Ground.

**Function Block Diagram**

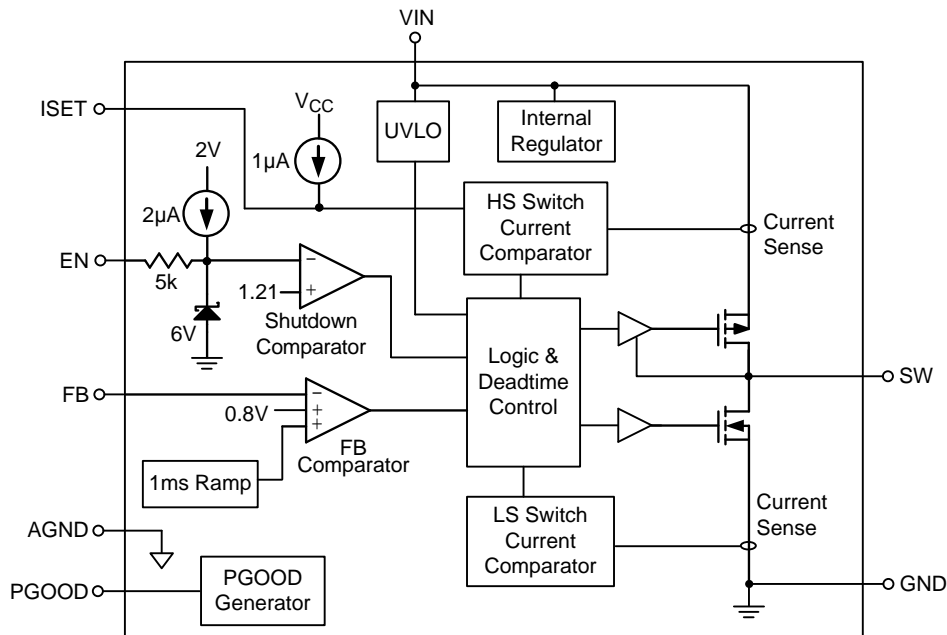

**Operation**

The RT6208 is a step-down DC/DC converter with internal power switches that uses Hysteresis Mode control, combining low quiescent current, which results in high efficiency across a wide range of load currents. Hysteresis Mode operation functions by using Boundary Conduction Mode (BCM) to ramp the inductor current through the internal power switches, followed by a sleep cycle where the power switches are off and the load current is supplied by the output capacitor. During the sleep cycle, the RT6208 draws only 25µA of supply current. At light loads, the BCM cycles are a small percentage of the total cycle time which minimizes the average supply current, greatly improving efficiency.

**Scheme of Hysteresis Mode**

The feedback comparator monitors the voltage on the V<sub>FB</sub> pin and compares it to an internal 800mV reference, as shown in Figure 1. If this voltage is greater than the reference, the comparator activates a sleep mode in which the power switches and current

comparators are disabled, reducing the VIN pin supply current to only 25µA. As the load current discharges the output capacitor, the voltage on the V<sub>FB</sub> pin decreases. When this voltage falls 5mV below the 800mV reference, the feedback comparator trips and enables BCM. At the beginning of the BCM, the internal high-side power switch (P-channel MOSFET) is turned on and the inductor current begins to ramp up. The inductor current increases until either the current exceeds the peak current comparator threshold, or the ON time of the high-side MOSFET exceeds 5µs during the time V<sub>FB</sub> is higher than 800mV, at which the high-side power switch is turned off, and the Low-side power switch is turned on. The inductor current ramps down until the reverse current is close to zero. If the voltage on the V<sub>FB</sub> pin is still less than the 800mV reference, the high-side power switch is turned on again and another cycle commences which keep the inductor current operated in a boundary conduction mode. The average current during the BCM will normally be greater than the average load current. For

this architecture, the maximum average output current is equal to half of the peak current. The hysteresis nature of this control architecture results in a switching frequency that is a function of the input voltage, output voltage and inductor value. This behavior provides inherent short-circuit protection. If the output is shorted

to ground, the inductor current will decay very slowly during a single switching cycle. Since the high-side switch turns on only when the inductor current is near zero, the RT6208 inherently switches at a lower frequency during short-circuit condition.

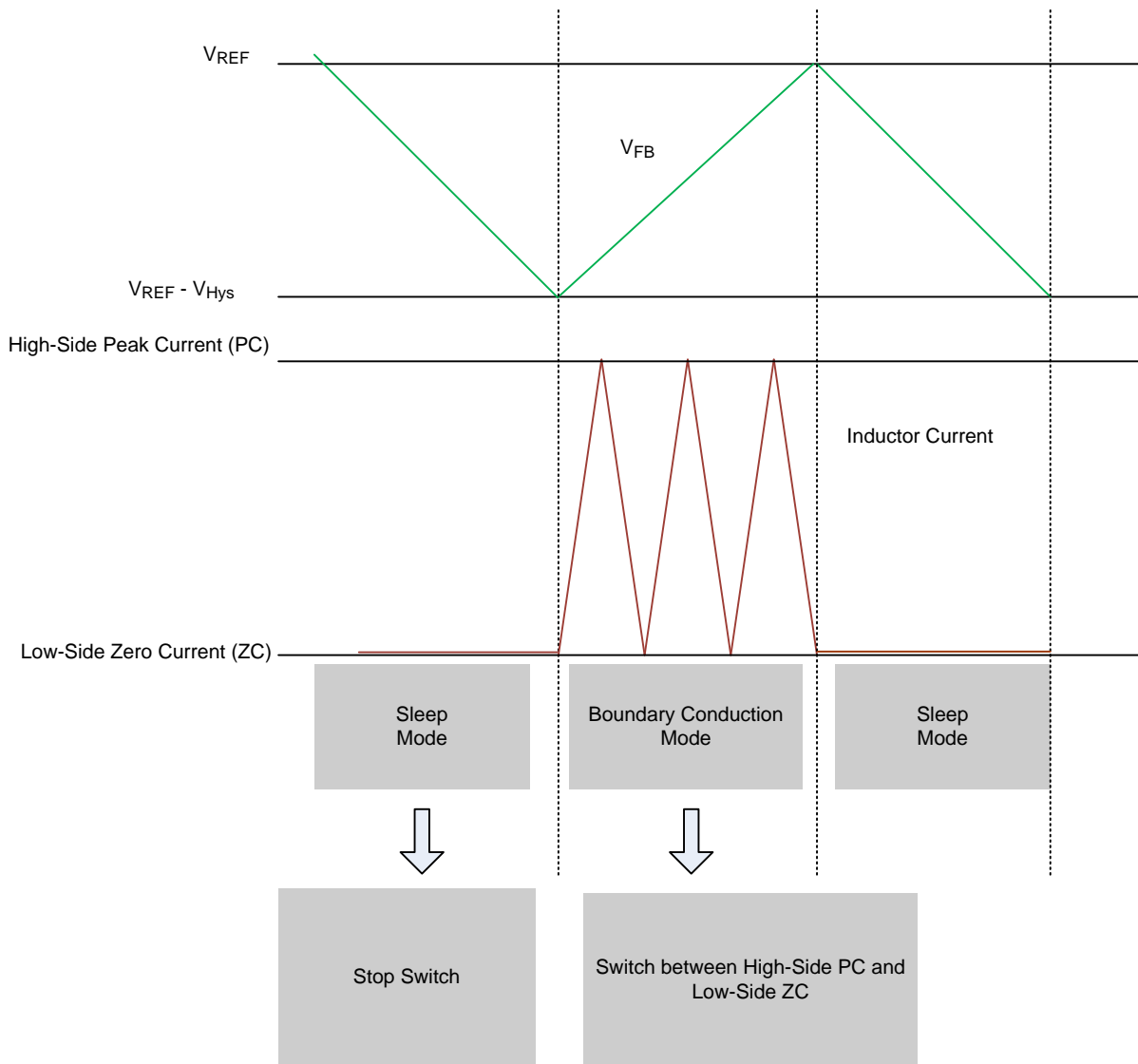

Figure 1. Hysteresis Mode

**Absolute Maximum Ratings** (Note 1)

- Supply Voltage, VIN ----- -0.3V to 40V
- Switch Voltage, SW ----- -0.3V to (VIN + 0.3V)  
     <10ns ----- -5V to 46.3V
- All Other Pins ----- -0.3V to 6V
- Power Dissipation, PD @ TA = 25°C  
     SOT-23-6 ----- 0.48W  
     SOT-23-8 ----- 0.53W
- Package Thermal Resistance (Note 2)  
     SOT-23-6, θJA ----- 208.2°C/W  
     SOT-23-6, θJC ----- 32°C/W  
     SOT-23-8, θJA ----- 186.2°C/W  
     SOT-23-8, θJC ----- 47.4°C/W
- Lead Temperature (Soldering, 10 sec.) ----- 260°C
- Junction Temperature ----- 150°C
- Storage Temperature Range ----- -65°C to 150°C
- ESD Susceptibility (Note 3)  
     HBM (Human Body Model) ----- 2kV  
     MM (Machine Model) ----- 200V

**Recommended Operating Conditions** (Note 4)

- Input Voltage Range ----- 4.75V to 36V
- Ambient Temperature Range ----- -40°C to 85°C
- Junction Temperature Range ----- -40°C to 125°C

**Electrical Characteristics**

(VIN = 12V, TA = 25°C, unless otherwise specified)

Parameter		Symbol	Test Conditions	Min	Typ	Max	Unit
Supply Current	Active Mode			--	160	190	μA
	Sleep Mode			--	25	40	μA
	Shutdown Mode		VEN = 0V	--	3	6	μA
Feedback Comparator Trip Voltage		VFB	VFB Rising	0.792	0.8	0.808	V
Feedback Comparator Hysteresis		VFBHYS		3	5	7	mV
Feedback Pin Current		IFB		-100	0	100	nA
High-Side Switch On-Resistance		RDS(ON)_H		--	3	--	Ω
Low-Side Switch On-Resistance		RDS(ON)_L		--	1.5	--	Ω
Enable Threshold Voltage			Enable Rising	1	1.2	1.4	V
Enable Hysteresis				--	100	--	mV
Input Under Voltage Lockout Threshold		VUVLO	VIN Rising	3.9	4.2	4.75	V

Parameter	Symbol	Test Conditions	Min	Typ	Max	Unit
Input Under Voltage Lockout Hysteresis	$\Delta V_{UVLO}$		--	300	--	mV
Soft-Start Period	t <sub>SS</sub>		--	1	--	ms
High-Side Peak Current Limit		ISET Floating	200	225	250	mA
		500k $\Omega$ from ISET to GND	--	135	--	
		ISET short to GND	--	50	--	
Peak Current Comparator Propagation Delay Time		ISET floating $\Delta I/\Delta t = 250\text{mA}/\mu\text{s}$	--	100	--	ns
Power Good Threshold - Rising		V <sub>FB</sub> Rising	--	87.5	--	%
Power Good Threshold - Falling		V <sub>FB</sub> Falling	--	82.5	--	%
Thermal Shutdown	T <sub>SD</sub>		--	150	--	°C

**Note 1.** Stresses beyond those listed “Absolute Maximum Ratings” may cause permanent damage to the device. These are stress ratings only, and functional operation of the device at these or any other conditions beyond those indicated in the operational sections of the specifications is not implied. Exposure to absolute maximum rating conditions may affect device reliability.

**Note 2.**  $\theta_{JA}$  is measured at T<sub>A</sub> = 25°C on a high effective thermal conductivity four-layer test board per JEDEC 51-7.  $\theta_{JC}$  is measured at the lead of the package.

**Note 3.** Devices are ESD sensitive. Handling precaution recommended.

**Note 4.** The device is not guaranteed to function outside its operating conditions.

**Typical Application Circuit**

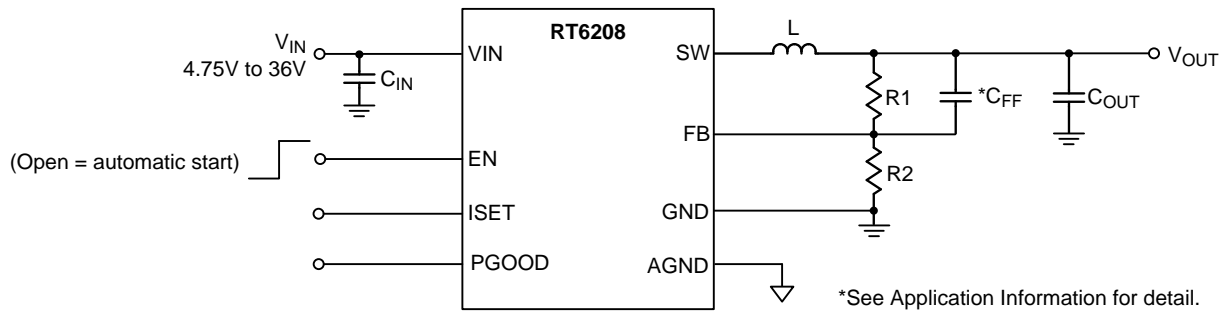

**(Recommended Component Selections for a 100mA Loading application of Popular output Voltage)**

V <sub>OUT</sub> (V)	C <sub>IN</sub> (μF)	C <sub>OUT</sub> (μF)	L (μH)	R <sub>2</sub> (kΩ)	R <sub>1</sub> (kΩ)	C <sub>FF</sub> (pF)	ISET
1.8	2.2	10	150	24	30	68	Floating
3.3	2.2	10	150	24	75	120	Floating
5	2.2	10	150	24	126	150	Floating

Typical Operating Characteristics

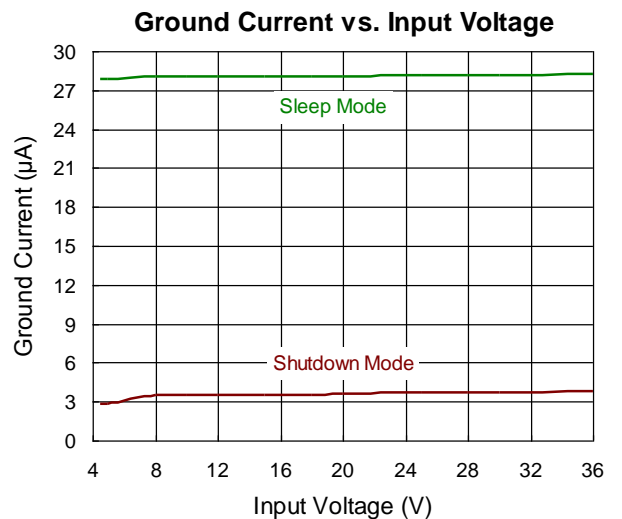
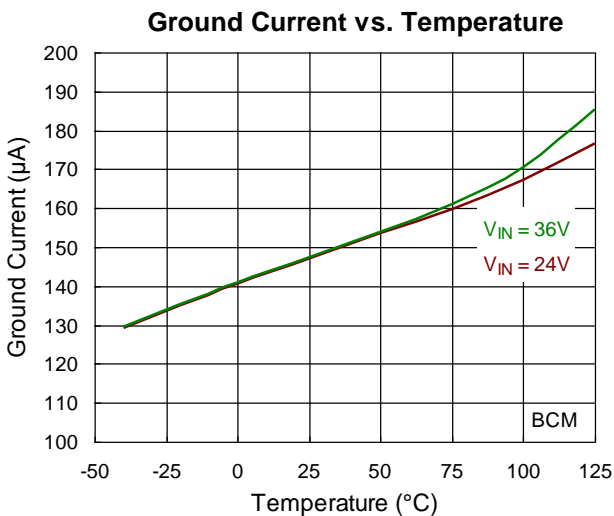
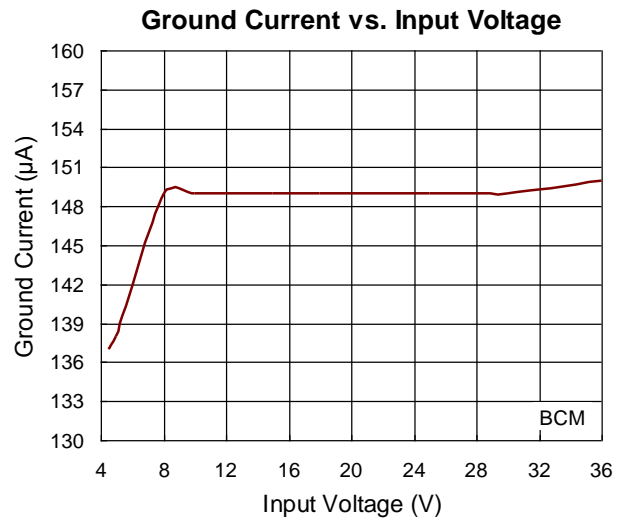
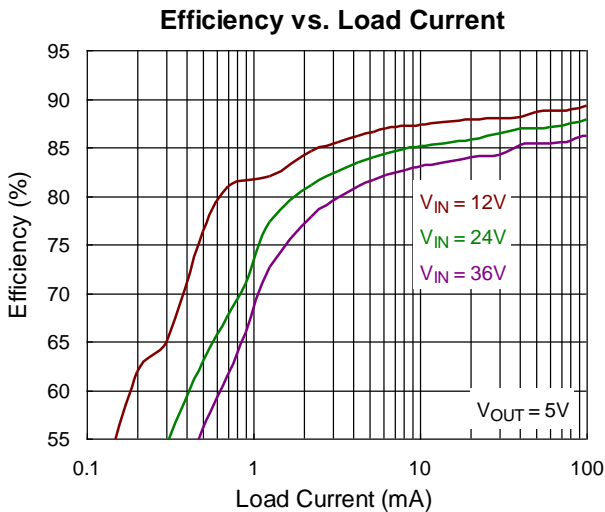
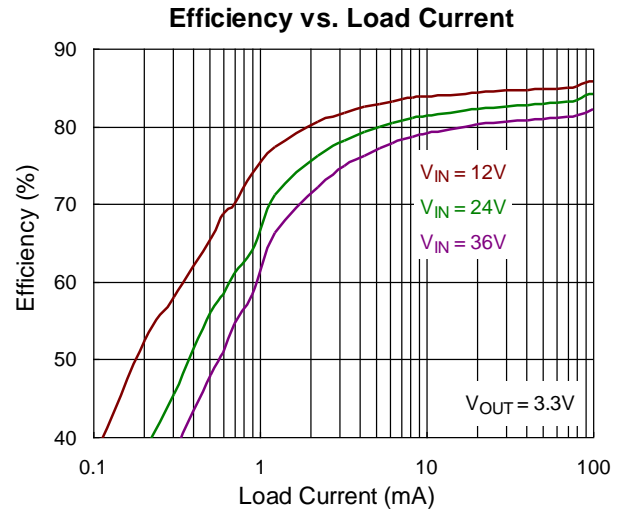
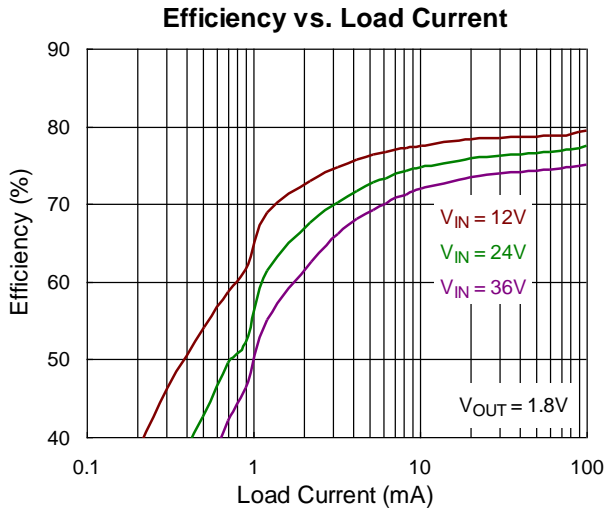



Ground Current vs. Temperature

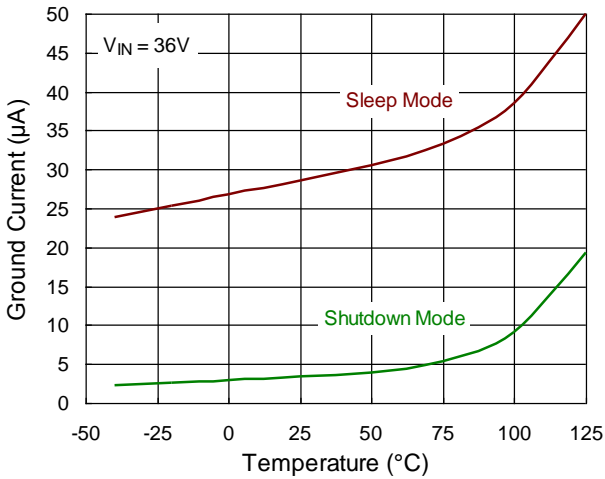

UVLO vs. Temperature

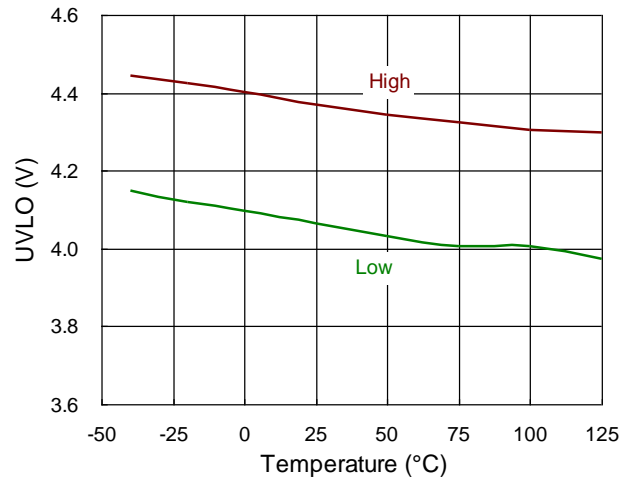

FB Voltage vs. Temperature

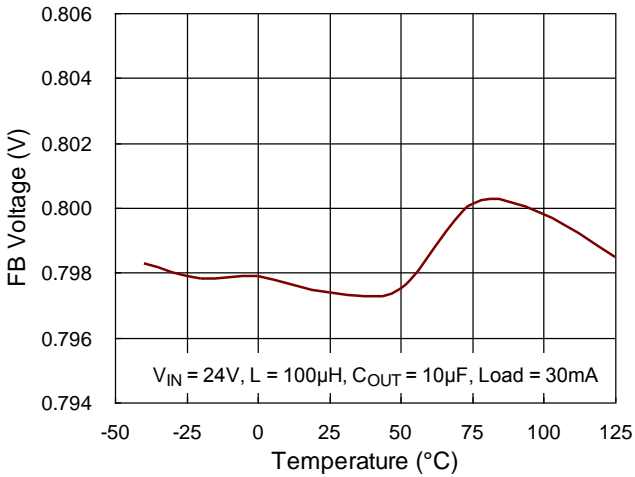

FB Voltage Hysteresis vs. Temperature

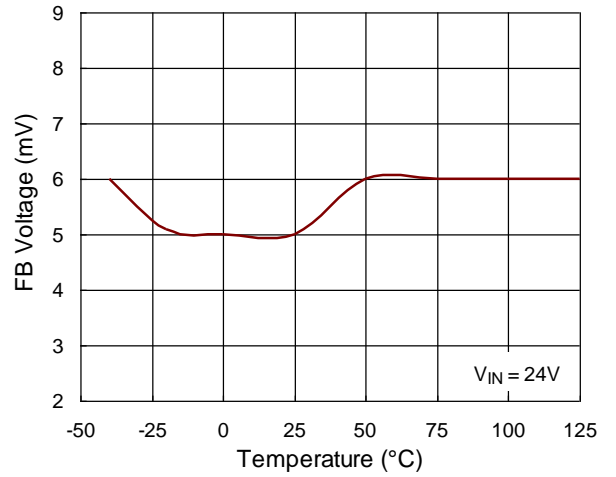

HS Peak Current Limit vs. Input Voltage

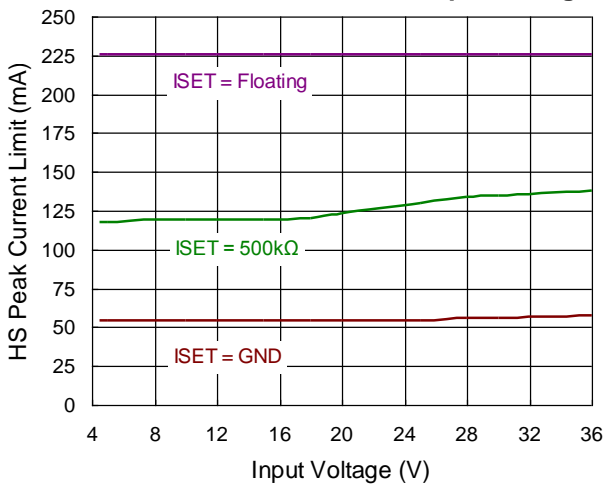

HS Peak Current Limit vs. Temperature

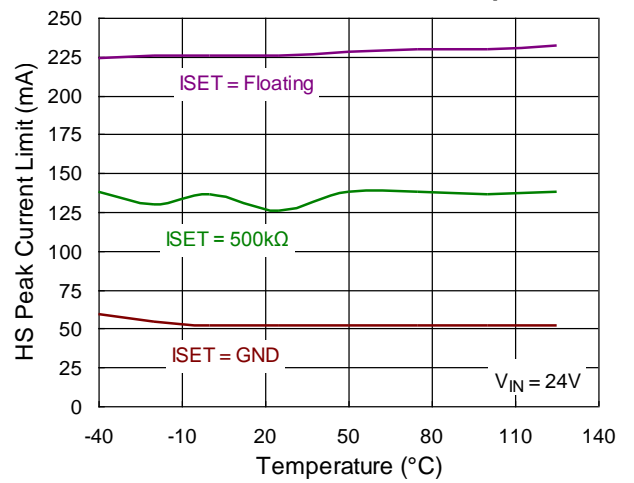

Switch On-Resistance vs. Input Voltage

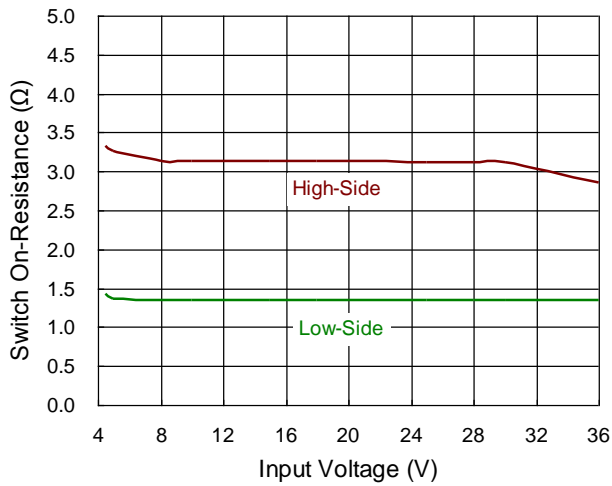

Switch On-Resistance vs. Temperature

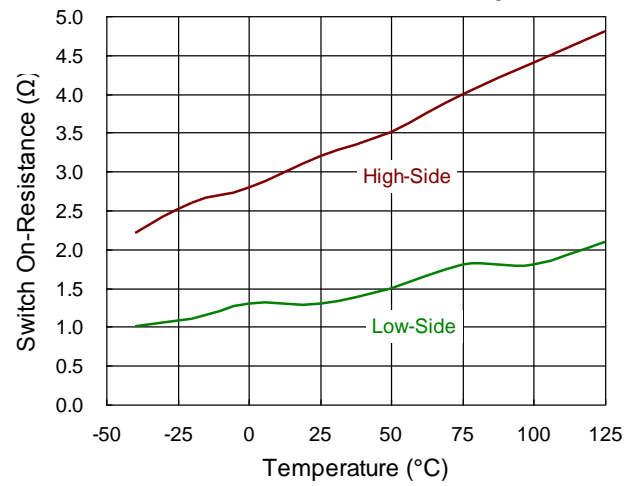

Switch Leakage Current vs. Temperature

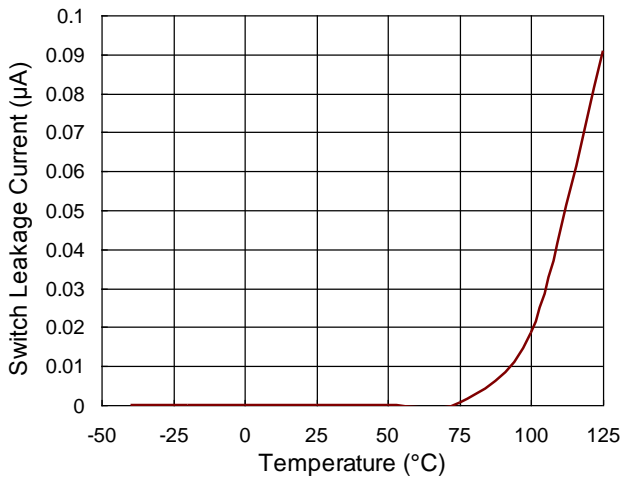

EN Threshold Voltage vs. Temperature

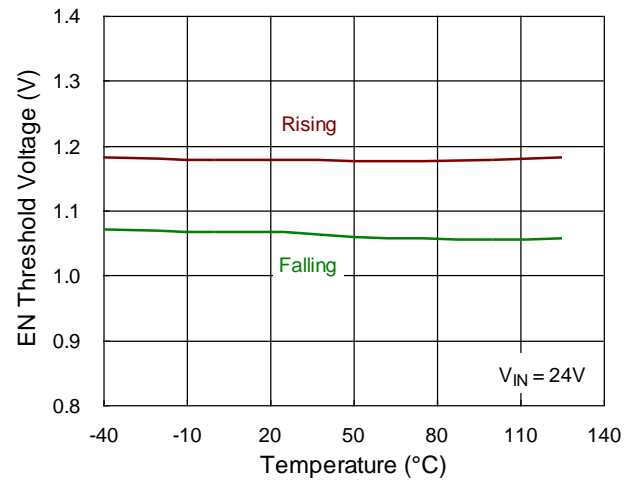

Switching

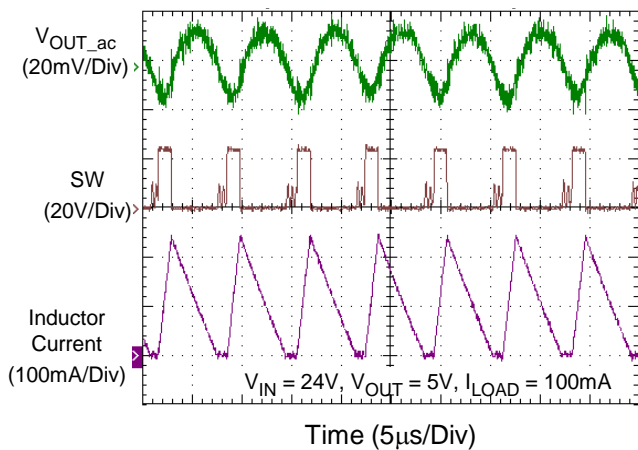

Soft-Start

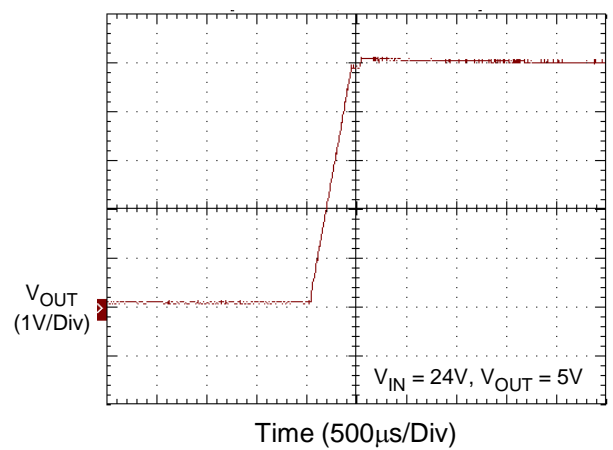

**Load Transient Response**

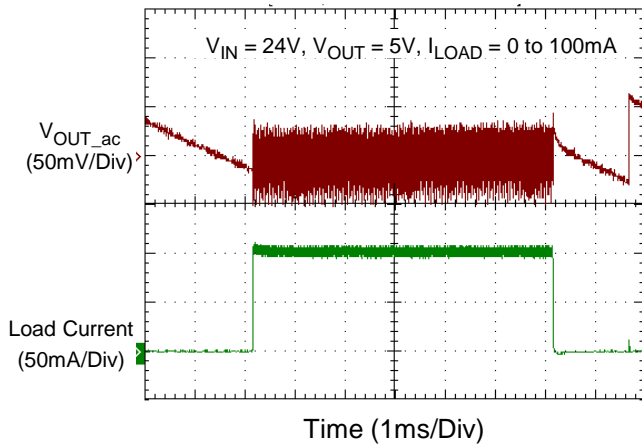

**Short Circuit Response**

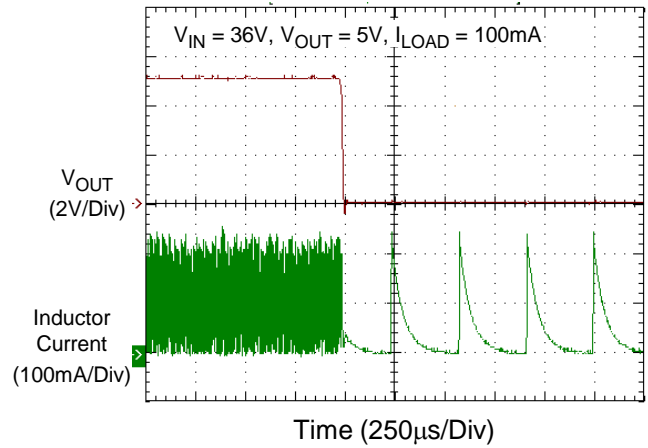

## Application Information

The typical RT6208 application circuit is shown on page 7 of this data sheet. External component selection is determined by the maximum load current requirement and begins with the selection of the peak current programming resistor,  $R_{ISET}$ . The inductor value  $L$  can then be determined, followed by capacitors  $C_{IN}$  and  $C_{OUT}$ .

### Peak Current Resistor Selection

The peak current comparator has a maximum current limit of 225mA nominally, which results in a maximum average current of 112mA. For applications that demand less current, the peak current threshold can be reduced to as little as 50mA. The threshold can be easily programmed with an appropriately chosen resistor ( $R_{ISET}$ ) between the ISET pin and ground. The value of resistor for a particular peak current can be computed by following equation

$$R_{ISET} = (I_{PEAK} - 0.05) \times 5.88 \times 10^6$$

where  $50\text{mA} < I_{PEAK} < 225\text{mA}$ .

The peak current is internally limited to be within the range of 50mA to 225mA. Shorting the ISET pin to ground programs the current limit to 50mA, and leaving it floating sets the current limit to the maximum value of 225mA. When selecting this resistor value, be aware that the maximum average output current for this architecture is limited to half of the peak current. Therefore, be sure to select a value that sets the peak current with enough margin to provide adequate load current under all foreseeable operating conditions.

### Output Voltage Setting and Feedback Network

The resistive divider allows the FB pin to sense the output voltage. The output voltage is set by an external resistive voltage divider according to the following equation :

$$V_{OUT} = V_{REF} \times \left( 1 + \frac{R_1}{R_2} \right)$$

Where  $V_{REF}$  is the reference voltage (0.8V typ.).

The resistive divider attenuates the ripple signal on FB pin as well. A small feed forward capacitor  $C_{FF}$  can be added in parallel with the upper feedback resistor  $R_1$ . It helps to reduce switch-noise coupling on the FB pin and increases the FB pin ripple voltage to improve switching stability and avoid double pulses. The  $C_{FF}$  value is dependent on the feedback network impedance and the peak-peak ripple voltage on the output. Recommended  $C_{FF}$  values range from 47pF to 470pF.

### Inductor Selection

The inductor, input voltage, output voltage and peak current determine the switching frequency of the RT6208. For a given input voltage, output voltage and peak current, the inductor value sets the maximum switching frequency when the load current is close to 1/2 of the peak current. A good first choice for the inductor value can be determined by the following equation :

$$L = \left( \frac{V_{OUT}}{f_{MAX} \times I_{PEAK}} \right) \times \left( 1 - \frac{V_{OUT}}{V_{IN}} \right)$$

The variation in switching frequency would be calculated with inductor, load current, input and output voltage. Large output capacitors will result in multiple switching cycles in BCM. The discharge time and charge time of operation frequency can follow below equation :

$$\text{Discharge time (Sleep Mode)} : T_1 = C_{OUT} \times \frac{V_{Hys.}}{I_{LOAD}}$$

Charge time (Boundary Conduction Mode) :

$$T_2 = C_{OUT} \times \frac{V_{Hys.}}{(0.5 \times I_{PEAK} - I_{LOAD})}$$

$$\text{Operation Frequency } f = \frac{1}{T1 + T2}$$

**Input Under Voltage Lockout**

The RT6208 implements a protection feature which disables switching when the input voltage is too low. If  $V_{IN}$  falls below 3.9V typical, an under voltage detector disables switching. Switching is enabled when the input voltage exceeds 4.2V typical (4.75V maximum).

**Enable Operation**

The EN pin can be used to shutdown or activate the chip. Pulling the EN pin low (<1V) will shutdown the device. During shutdown mode, the RT6208 quiescent current drops to lower than 3µA. Driving the EN pin high (>1.4V) will turn on the device again. Leaving the EN pin floating will pull the EN pin up to 2V internally and enable RT6208.

**Soft-Start**

The RT6208 provides an internal soft-start function to prevent large inrush current and output voltage overshoot when the converter starts up. The soft-start automatically begins once the chip is enabled. During soft-start, it clamps the ramp of internal reference voltage which is compared with FB signal. The typical soft-start duration is 1ms.

**C<sub>IN</sub> and C<sub>OUT</sub> Selection**

The input capacitance,  $C_{IN}$ , is needed to filter the triangular current at the Source of the high-side MOSFET. To prevent large ripple current, a low ESR input capacitor sized for the maximum RMS current should be used. The approximate RMS current equation is given :

$$I_{RMS} = I_{OUT(MAX)} \frac{V_{OUT}}{V_{IN}} \sqrt{\frac{V_{IN}}{V_{OUT}} - 1}$$

This formula has a maximum at  $V_{IN} = 2V_{OUT}$ , where  $I_{RMS} = I_{OUT} / 2$ . This simple worst case condition is commonly used for design because even significant

deviations do not offer much relief. Choose a capacitor rated at a higher temperature than required. Several capacitors may also be paralleled to meet size or height requirements in the design.

The output capacitor,  $C_{OUT}$ , filters the inductor's ripple current and stores energy to satisfy the load current when the RT6208 is in sleep mode. The value of the output capacitor must be large enough to accept the energy stored in the inductor without a large change in output voltage. To achieve an output voltage peak-peak ripple less than 1% of the output voltage, the output capacitor must be :

$$C_{OUT} \geq 50 \times L \times \left( \frac{I_{PEAK}}{V_{OUT}} \right)^2$$

**Thermal Considerations**

For continuous operation, do not exceed absolute maximum junction temperature. The maximum power dissipation depends on the thermal resistance of the IC package, PCB layout, rate of surrounding airflow, and difference between junction and ambient temperature. The maximum power dissipation can be calculated by the following formula :

$$P_{D(MAX)} = (T_{J(MAX)} - T_A) / \theta_{JA}$$

where  $T_{J(MAX)}$  is the maximum junction temperature,  $T_A$  is the ambient temperature, and  $\theta_{JA}$  is the junction to ambient thermal resistance.

For recommended operating condition specifications, the maximum junction temperature is 125°C. The junction to ambient thermal resistance,  $\theta_{JA}$ , is layout dependent. For SOT-23-6 package, the thermal resistance,  $\theta_{JA}$ , is 208.2°C/W on a standard JEDEC 51-7 four-layer thermal test board. For SOT-23-8 package, the thermal resistance,  $\theta_{JA}$ , is 186.2°C/W on a standard JEDEC 51-7 four-layer thermal test board.

The maximum power dissipation at  $T_A = 25^\circ\text{C}$  can be calculated by the following formula :

$$P_{D(MAX)} = (125^\circ\text{C} - 25^\circ\text{C}) / (208.2^\circ\text{C/W}) = 0.48\text{W for SOT-23-6 package}$$

$P_{D(MAX)} = (125^{\circ}\text{C} - 25^{\circ}\text{C}) / (186.2^{\circ}\text{C}/\text{W}) = 0.53\text{W}$  for SOT-23-8 package

The maximum power dissipation depends on the operating ambient temperature for fixed  $T_{J(MAX)}$  and thermal resistance,  $\theta_{JA}$ . The derating curve in Figure 2 allows the designer to see the effect of rising ambient temperature on the maximum power dissipation.

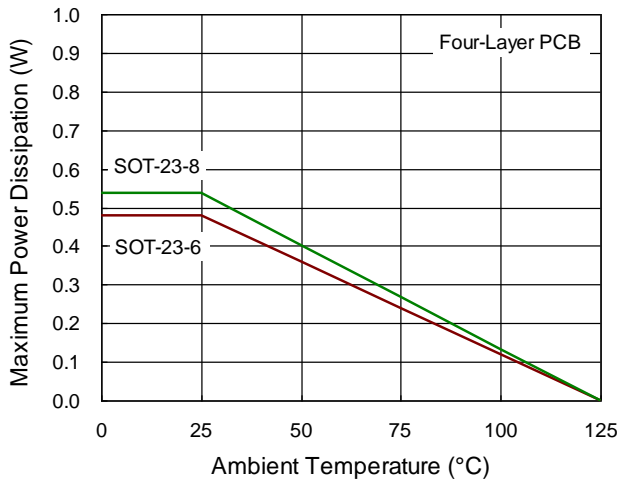
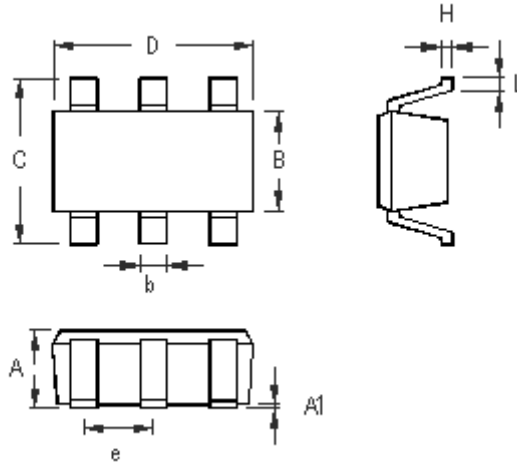

Figure 2. Derating Curve of Maximum Power Dissipation

**Outline Dimension**



Symbol	Dimensions In Millimeters		Dimensions In Inches	
	Min	Max	Min	Max
A	0.889	1.295	0.031	0.051
A1	0.000	0.152	0.000	0.006
B	1.397	1.803	0.055	0.071
b	0.250	0.560	0.010	0.022
C	2.591	2.997	0.102	0.118
D	2.692	3.099	0.106	0.122
e	0.838	1.041	0.033	0.041
H	0.080	0.254	0.003	0.010
L	0.300	0.610	0.012	0.024

**SOT-23-6 Surface Mount Package**

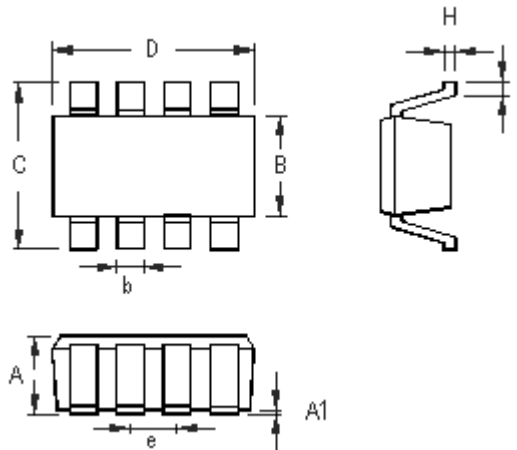

Symbol	Dimensions In Millimeters		Dimensions In Inches	
	Min	Max	Min	Max
A	1.000	1.450	0.039	0.057
A1	0.000	0.150	0.000	0.006
B	1.500	1.700	0.059	0.067
b	0.220	0.500	0.009	0.020
C	2.600	3.000	0.102	0.118
D	2.800	3.000	0.110	0.118
e	0.585	0.715	0.023	0.028
H	0.100	0.220	0.004	0.009
L	0.300	0.600	0.012	0.024

SOT-23-8 Surface Mount Package

**Richtek Technology Corporation**

14F, No. 8, Tai Yuen 1<sup>st</sup> Street, Chupei City  
 Hsinchu, Taiwan, R.O.C.  
 Tel: (8863)5526789

Richtek products are sold by description only. Richtek reserves the right to change the circuitry and/or specifications without notice at any time. Customers should obtain the latest relevant information and data sheets before placing orders and should verify that such information is current and complete. Richtek cannot assume responsibility for use of any circuitry other than circuitry entirely embodied in a Richtek product. Information furnished by Richtek is believed to be accurate and reliable. However, no responsibility is assumed by Richtek or its subsidiaries for its use; nor for any infringements of patents or other rights of third parties which may result from its use. No license is granted by implication or otherwise under any patent or patent rights of Richtek or its subsidiaries.

Copyright © 2016 Richtek Technology Corporation. All rights reserved. **RICHTEK** is a registered trademark of Richtek Technology Corporation.