

Product Overview

The QPD1003 is a 500 W (P_{3dB}) internally matched discrete GaN on SiC HEMT which operates from 1.2 to 1.4 GHz and a 50V supply rail. The device is GaN IMFET fully matched to 50 Ω in an industry standard air cavity package and is ideally suited for military and civilian radar. The device can support pulsed and linear operations.

ROHS compliant.

Evaluation boards are available upon request.



Functional Block Diagram

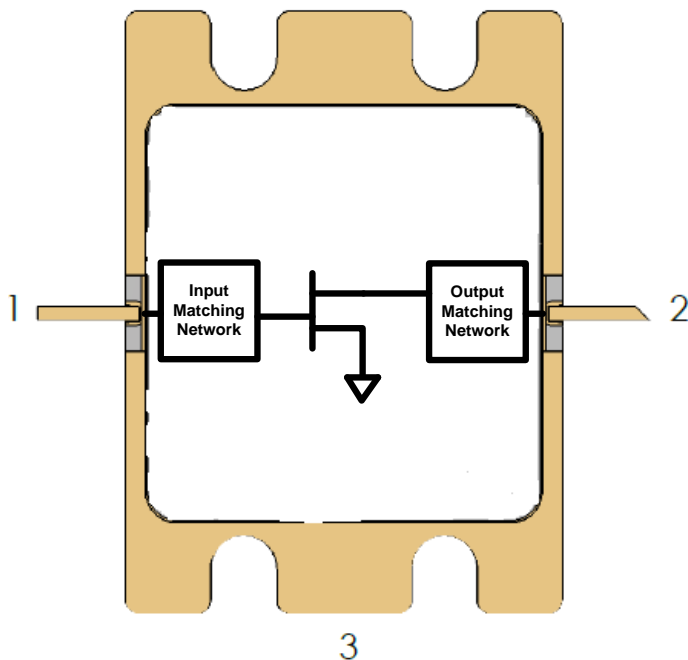

Key Features

- Frequency: 1.2 to 1.4 GHz
 - Output Power (P_{3dB})¹: 540 W
 - Linear Gain¹: 19.9 dB
 - Typical PAE_{3dB}¹: 66.7%
 - Operating Voltage: 50 V
 - Low thermal resistance package
 - Pulse capable
- Note 1: @ 1.3 GHz

Applications

- Military radar
- Civilian radar

Part No.	Description
QPD1003	1.2 – 1.4 GHz RF IMFET
QPD1003PCB401	1.2 – 1.4 GHz EVB

Absolute Maximum Ratings¹

Parameter	Rating	Units
Breakdown Voltage, BV_{DG}	+145	V
Gate Voltage Range, V_G	-7 to +1.5	V
Drain Current	20	A
Gate Current Range, I_G	See page 4.	mA
Power Dissipation, 10% DC 1 mS PW, P_{DISS}	410	W
RF Input Power, 10% DC 1 mS PW, 1.3 GHz, $T = 25\text{ }^\circ\text{C}$	+42	dBm
Mounting Temperature (30 Seconds)	320	$^\circ\text{C}$
Storage Temperature	-65 to +150	$^\circ\text{C}$

Notes:

1. Operation of this device outside the parameter ranges given above may cause permanent damage.

Recommended Operating Conditions¹

Parameter	Min	Typ	Max	Units
Operating Temp. Range	-40	+25	+85	$^\circ\text{C}$
Drain Voltage Range, V_D	+28	+50	+55	V
Drain Bias Current, I_{DQ}	-	750	-	mA
Drain Current, I_D	-	15	-	A
Gate Voltage, V_G ⁴	-	-2.8	-	V
Power Dissipation, Pulsed (P_D) ^{2, 3}	-	-	370	W

Notes:

1. Electrical performance is measured under conditions noted in the electrical specifications table. Specifications are not guaranteed over all recommended operating conditions.
2. Package base at 85 $^\circ\text{C}$
3. Pulse Width = 1 mS, Duty Cycle = 10%
4. To be adjusted to desired I_{DQ}

Pulsed Characterization – Load-Pull Performance – Power Tuned¹

Parameters	Typical Values			Unit
Frequency, F	1.2	1.3	1.4	GHz
Linear Gain, G_{LIN}	19	19.9	18.6	dB
Output Power at 3dB compression point, P_{3dB}	57.3	57.3	57	dBm
Power-Added-Efficiency at 3dB compression point, PAE_{3dB}	55.1	57.6	56.9	%
Gain at 3dB compression point	16	16.9	15.6	dB

Notes:

1. Test conditions unless otherwise noted: $V_D = +50\text{ V}$, $I_{DQ} = 750\text{ mA}$, $Temp = +25\text{ }^\circ\text{C}$

Pulsed Characterization – Load-Pull Performance – Efficiency Tuned¹

Parameters	Typical Values			Unit
Frequency, F	1.2	1.3	1.4	GHz
Linear Gain, G_{LIN}	20.3	20.6	19.4	dB
Output Power at 3dB compression point, P_{3dB}	55.4	55.6	55.3	dBm
Power-Added-Efficiency at 3dB compression point, PAE_{3dB}	70.3	66.7	67.4	%
Gain at 3dB compression point, G_{3dB}	17.3	17.6	16.4	dB

Notes:

1. Test conditions unless otherwise noted: $V_D = +50\text{ V}$, $I_{DQ} = 750\text{ mA}$, $Temp = +25\text{ }^\circ\text{C}$

RF Characterization – 1.2 – 1.4 GHz EVB Performance At 1.2 GHz¹

Parameter	Min	Typ	Max	Units
Linear Gain, G_{LIN}	–	18.6	–	dB
Output Power at 3dB compression point, P_{3dB}	–	57.1	–	dBm
Power-Added Efficiency at 3dB compression point, PAE_{3dB}	–	57.7	–	%
Gain at 3dB compression point, G_{3dB}	–	15.6	–	dB

Notes:

1. $V_D = +50\text{ V}$, $I_{DQ} = 750\text{ mA}$, Temp = +25 °C, CW

RF Characterization – 1.2 – 1.4 GHz EVB Performance At 1.3 GHz¹

Parameter	Min	Typ	Max	Units
Linear Gain, G_{LIN}	–	19.8	–	dB
Output Power at 3dB compression point, P_{3dB}	–	56.6	–	dBm
Power-Added Efficiency at 3dB compression point, PAE_{3dB}	–	62.0	–	%
Gain at 3dB compression point, G_{3dB}	–	16.8	–	dB

Notes:

1. $V_D = +50\text{ V}$, $I_{DQ} = 750\text{ mA}$, Temp = +25 °C, CW

RF Characterization – 1.2 – 1.4 GHz EVB Performance At 1.4 GHz¹

Parameter	Min	Typ	Max	Units
Linear Gain, G_{LIN}	–	18.5	–	dB
Output Power at 3dB compression point, P_{3dB}	–	56.4	–	dBm
Power-Added Efficiency at 3dB compression point, PAE_{3dB}	–	59.2	–	%
Gain at 3dB compression point, G_{3dB}	–	15.5	–	dB

Notes:

1. $V_D = +50\text{ V}$, $I_{DQ} = 750\text{ mA}$, Temp = +25 °C, CW

RF Characterization – Mismatch Ruggedness at 1.3 GHz¹

Symbol	Parameter	dB Compression	Typical
VSWR	Impedance Mismatch Ruggedness	3	5:1

Notes:

1. Test conditions unless otherwise noted: $T_A = 25\text{ °C}$, $V_D = 50\text{ V}$, $I_{DQ} = 750\text{ mA}$, 1 mS PW, 10% DC
2. Driving input power is determined at pulsed compression under matched condition at EVB output connector.

Maximum Gate Current

Maximum Gate Current Vs. IR Surface Temperature

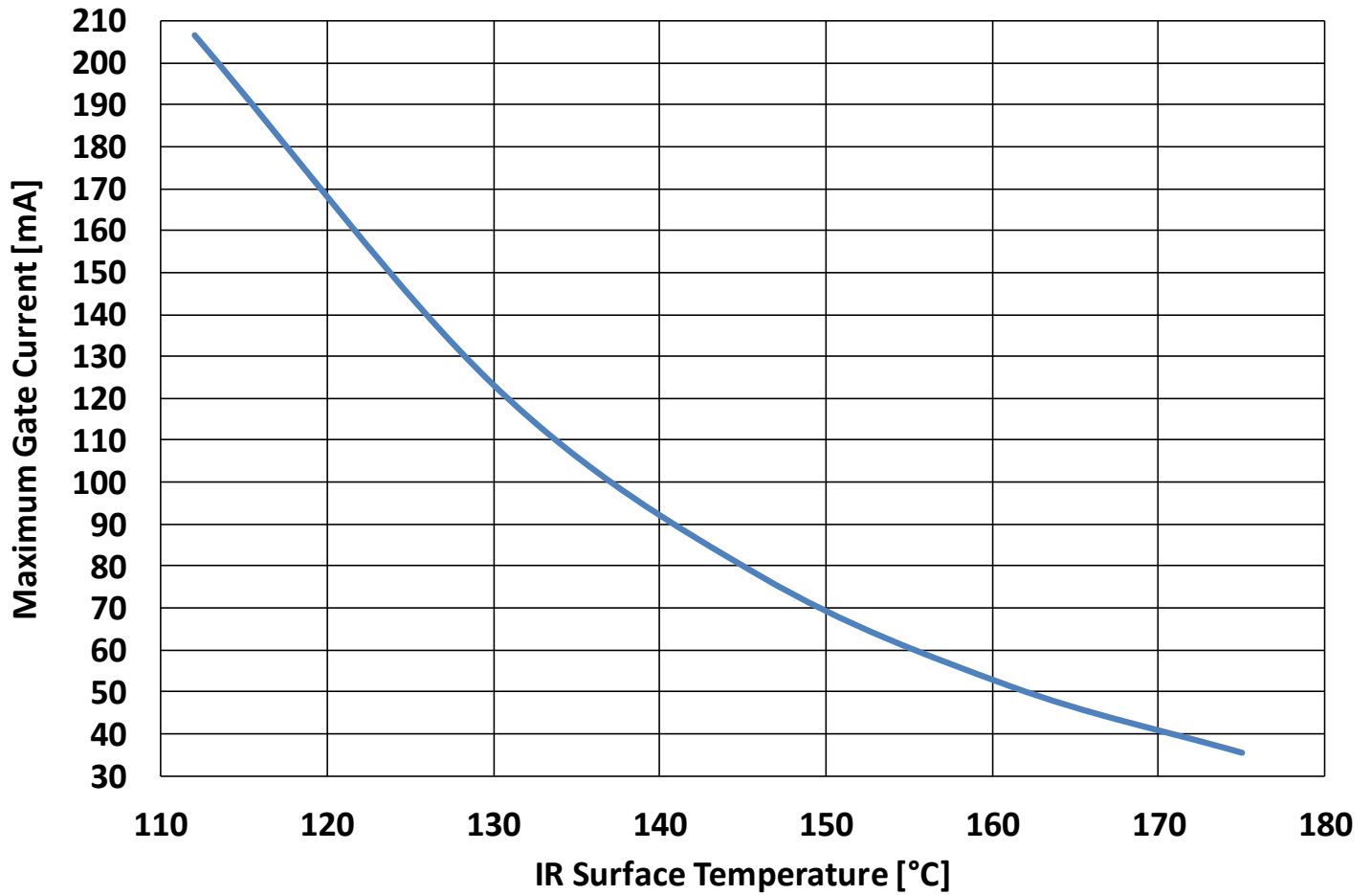

Thermal and Reliability Information – Pulsed

Peak IR Surface Temperature vs. Pulse Width

Pdiss = 346 W, Base Temperature @ 85 °C

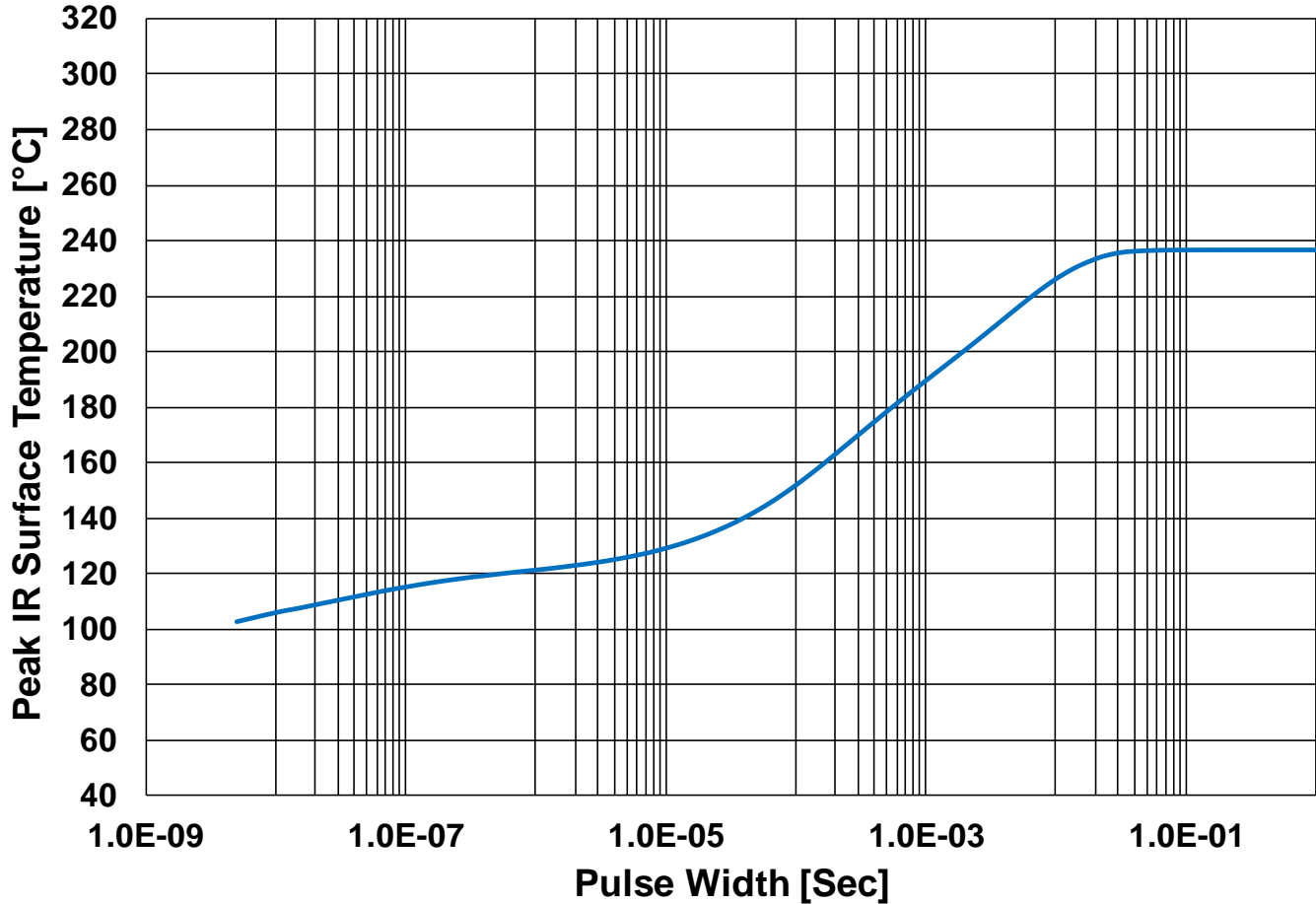

Parameter	Conditions	Values	Units
Thermal Resistance, IR ¹ (θ_{JC})	85 °C back side temperature	0.30	°C/W
Peak IR Surface Temperature ¹ (T_{CH})	346 W Pdiss, 1 mS PW, 10% DC	189	°C

¹Refer to the following document [GaN Device Channel Temperature, Thermal Resistance, and Reliability Estimates](#)

Load-Pull Smith Charts^{1, 2, 3}

Notes:

1. $V_D = 50\text{ V}$, $I_{DQ} = 750\text{ mA}$, 1 mS PW, 10% DC pulsed. Performance is at 3dB gain compression referenced to peak gain.
2. See page 14 for load-pull and source-pull reference planes. 50-Ω load-pull TRL fixtures are built with 20-mil RO4350B material.
3. NaN means the impedances are either undefined or varying in load-pull system.

1.2GHz, Load-pull

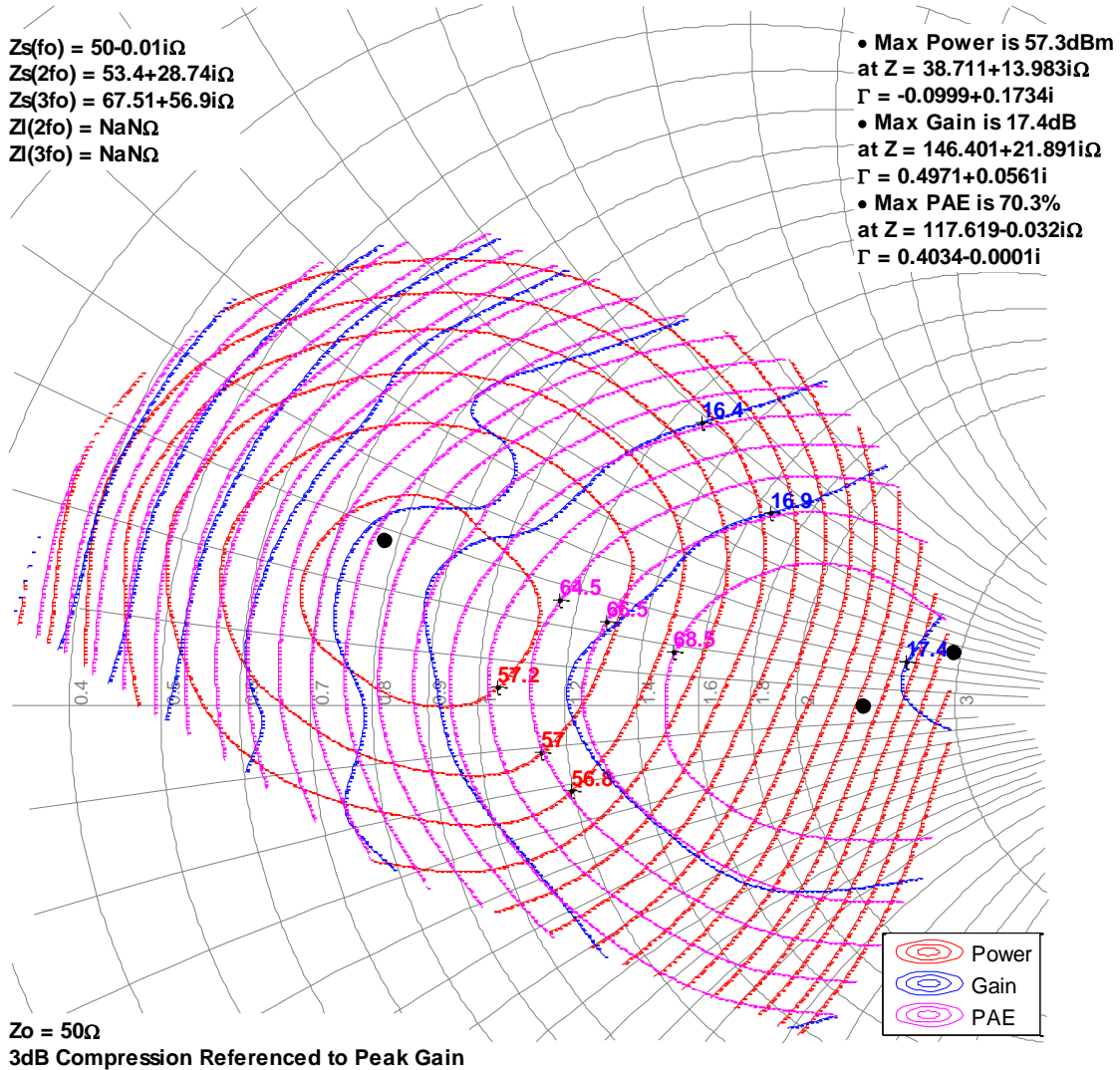

Load-Pull Smith Charts^{1, 2, 3}

Notes:

1. $V_D = 50\text{ V}$, $I_{DQ} = 750\text{ mA}$, 1 mS PW, 10% DC pulsed. Performance is at 3dB gain compression referenced to peak gain.
2. See page 14 for load-pull and source-pull reference planes. 50-Ω load-pull TRL fixtures are built with 20-mil RO4350B material.
3. NaN means the impedances are either undefined or varying in load-pull system.

1.3GHz, Load-pull

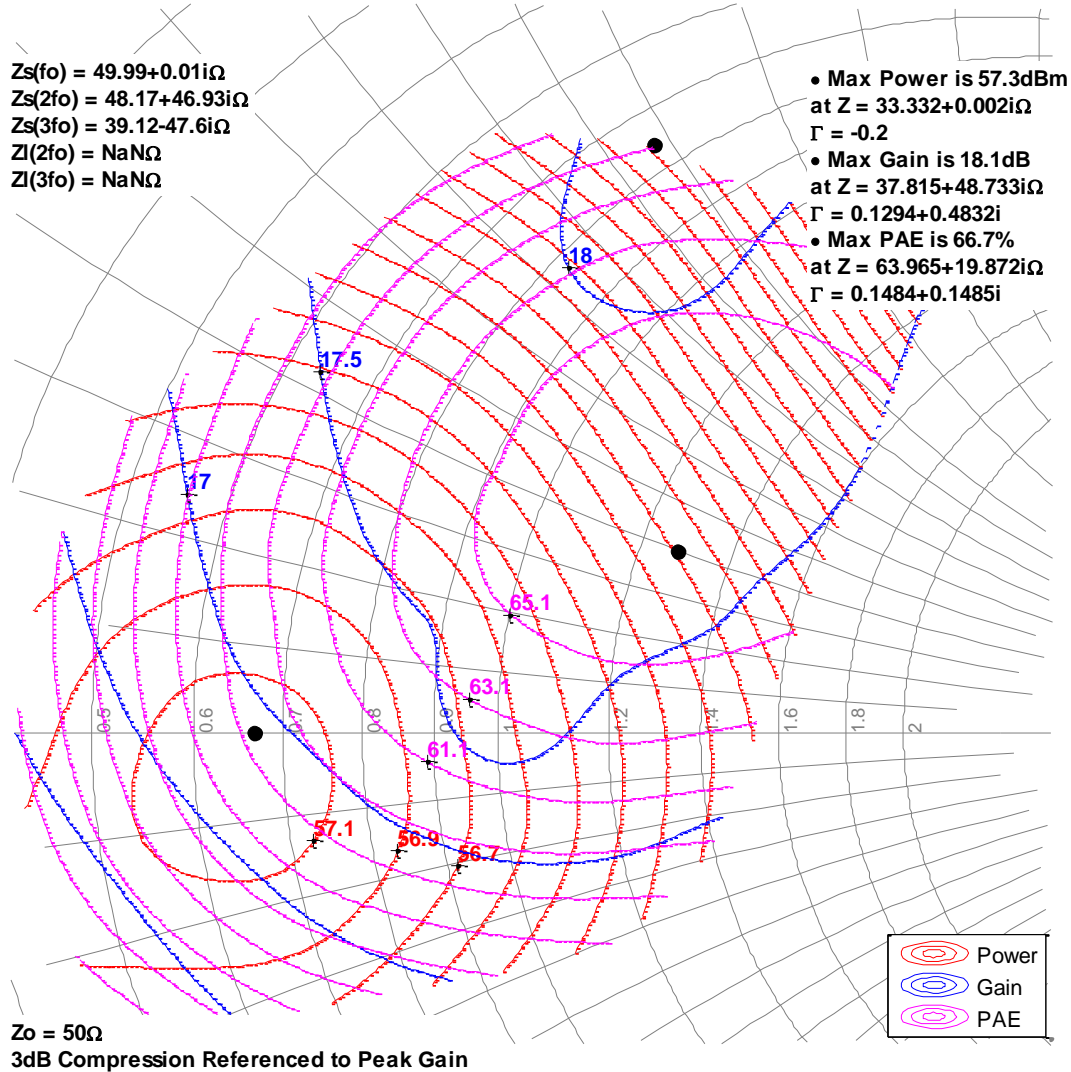

Load-Pull Smith Charts^{1, 2, 3}

Notes:

1. $V_D = 50\text{ V}$, $I_{DQ} = 750\text{ mA}$, 1 mS PW, 10% DC pulsed. Performance is at 3dB gain compression referenced to peak gain.
2. See page 14 for load-pull and source-pull reference planes. 50- Ω load-pull TRL fixtures are built with 20-mil RO4350B material.
3. NaN means the impedances are either undefined or varying in load-pull system.

1.4GHz, Load-pull

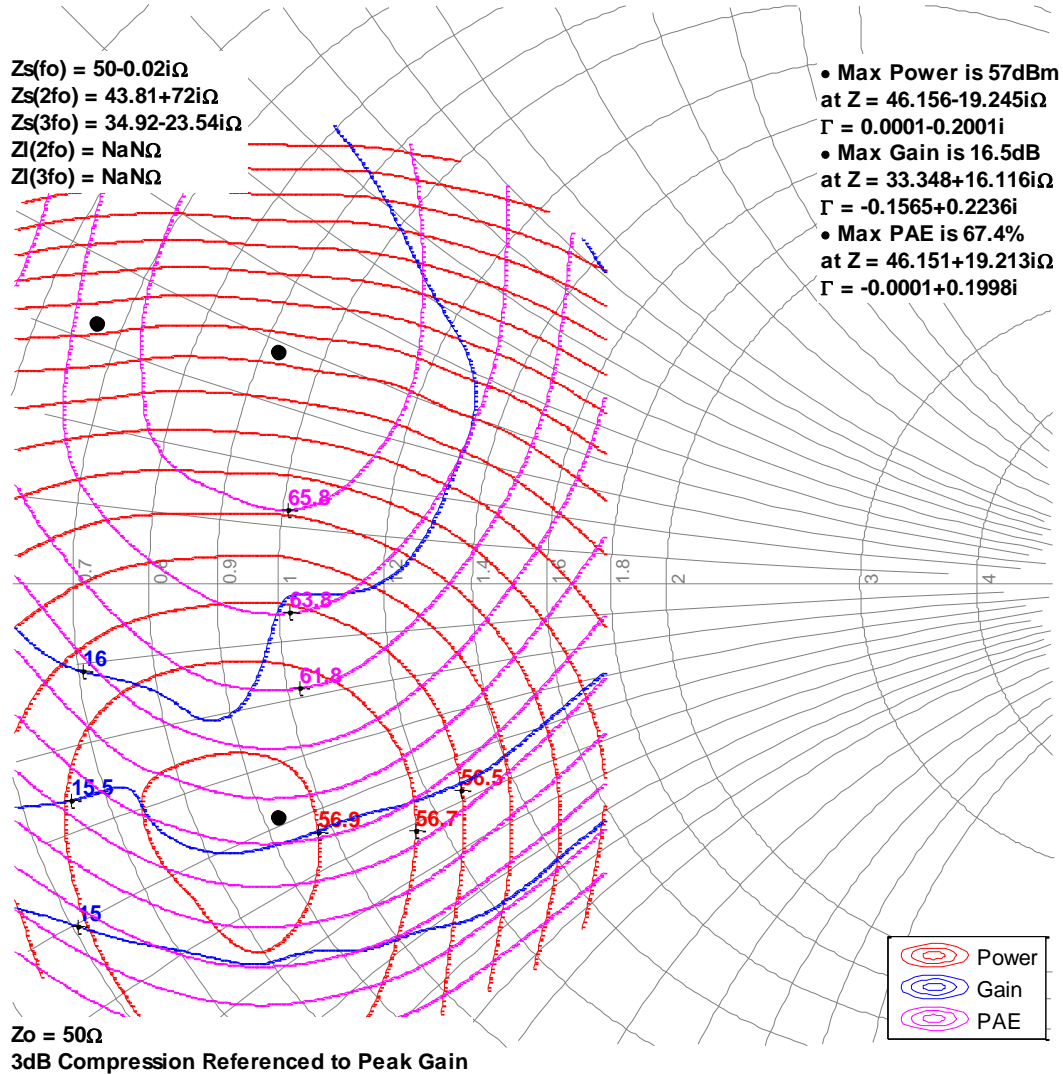

Typical Performance – Load-Pull Drive-up^{1, 2}

Notes:

1. 1 mS PW, 10% DC pulsed signal, $V_D = 50\text{ V}$, $I_{DQ} = 750\text{ mA}$
2. See page 14 for load-pull and source-pull reference planes where the performance was measured.

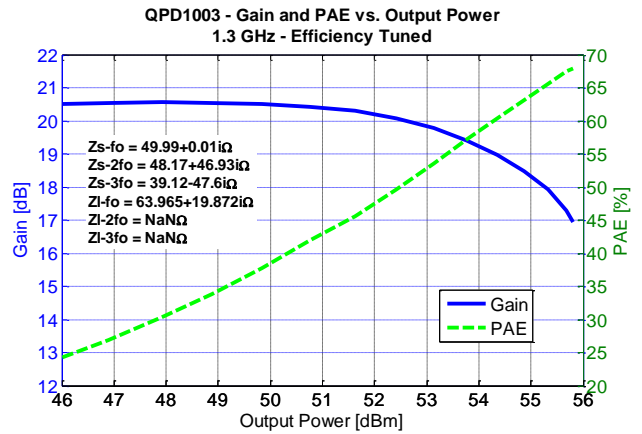
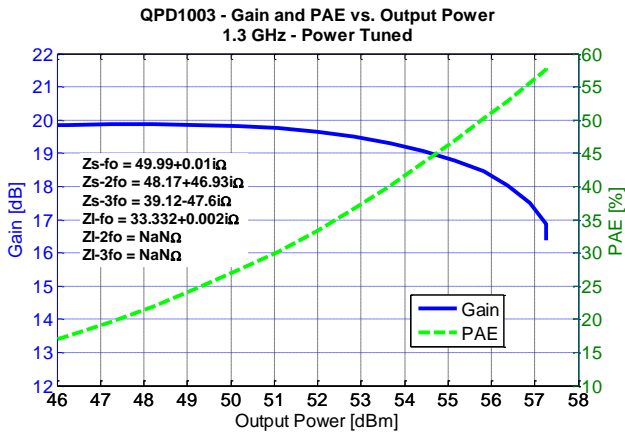
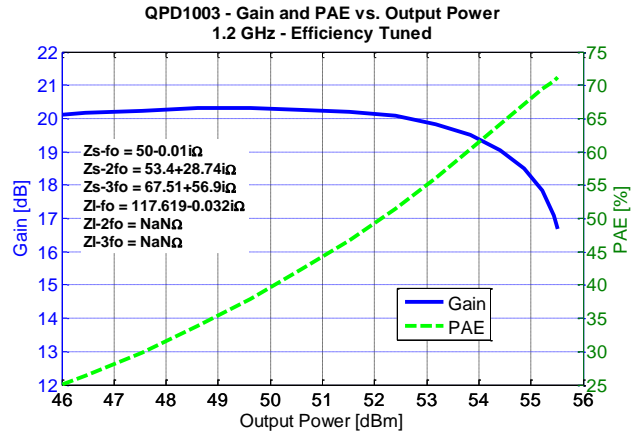
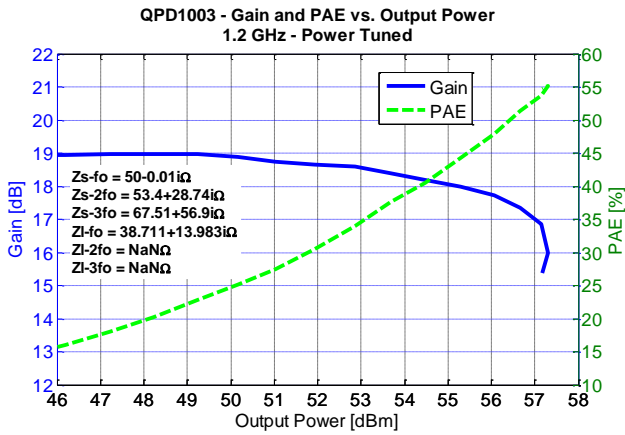

Typical Performance – Load-Pull Drive-up^{1, 2}

Notes:

1. 1 mS PW, 10% DC pulsed signal, $V_D = 50\text{ V}$, $I_{DQ} = 750\text{ mA}$
2. See page 14 for load-pull and source-pull reference planes where the performance was measured.

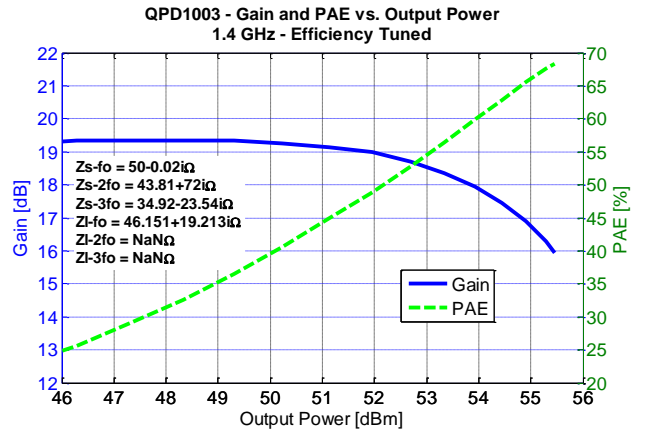
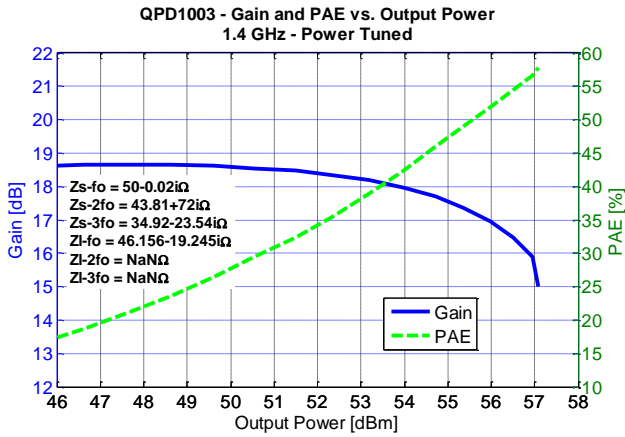

Power Drive-up Performance Over Temperatures Of 1.2 – 1.4 GHz EVB¹

Notes:

- $V_D = 50\text{ V}$, $I_{DQ} = 750\text{ mA}$, 1 mS PW , $10\% \text{ DC}$

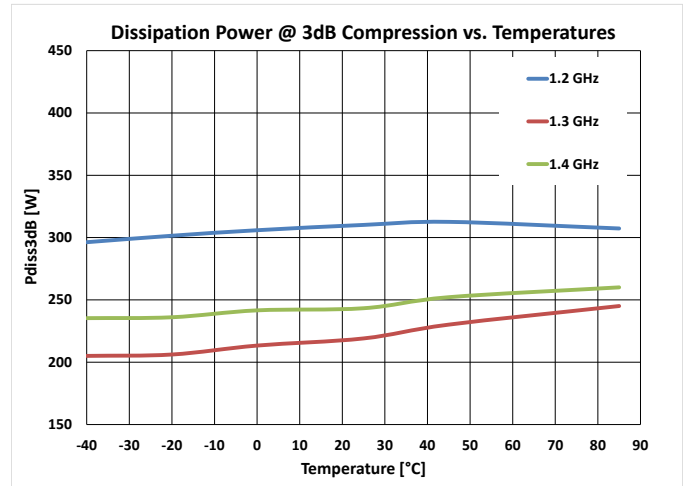
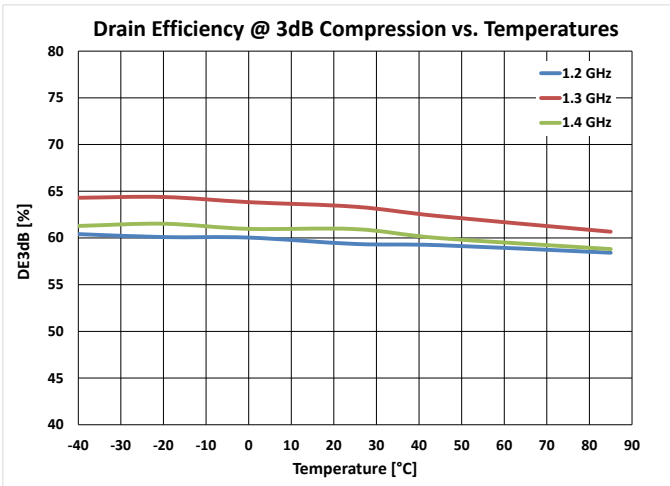
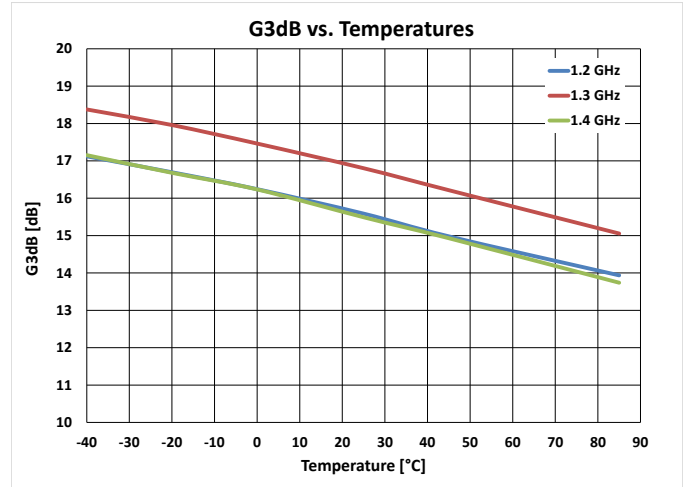
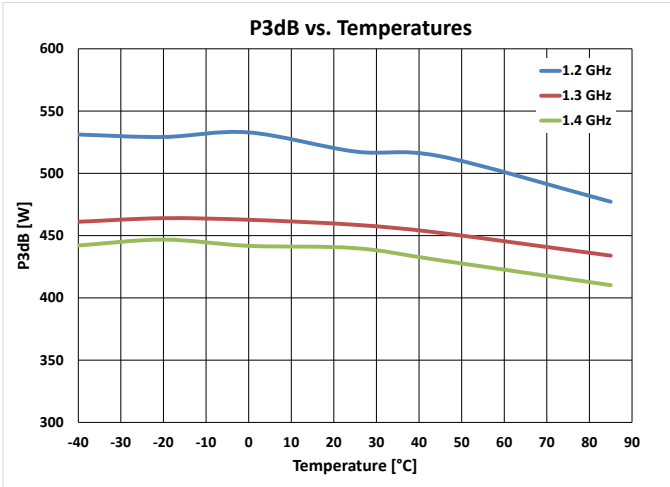

Power Drive-up Performance At 25 °C Of 1.2 – 1.4 GHz EVB¹

Notes:

- $V_D = 50\text{ V}$, $I_{DQ} = 750\text{ mA}$, 1 mS PW, 10% DC

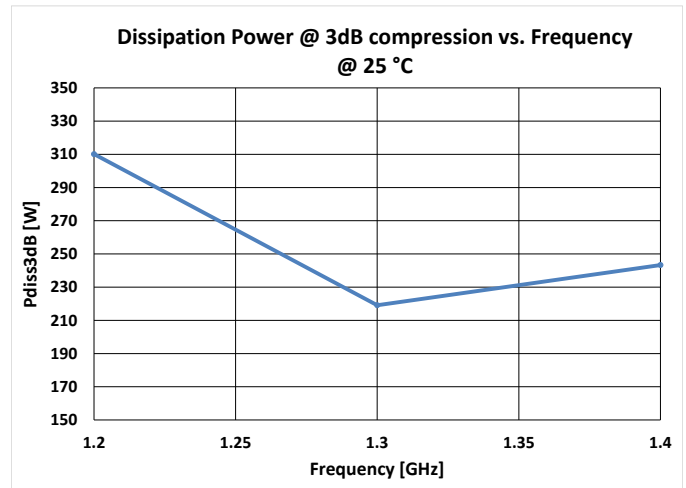
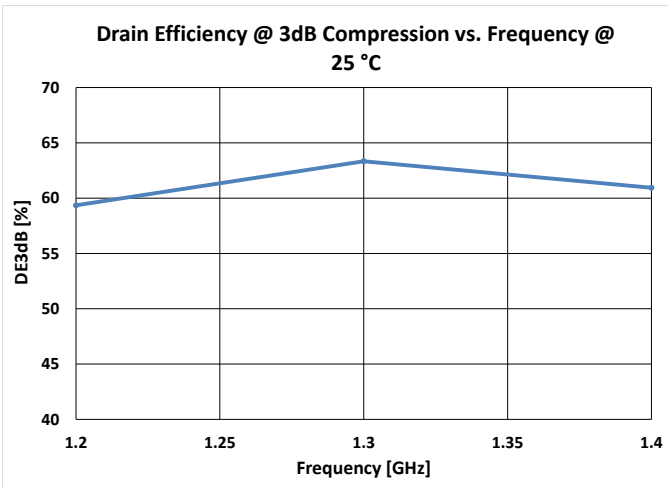
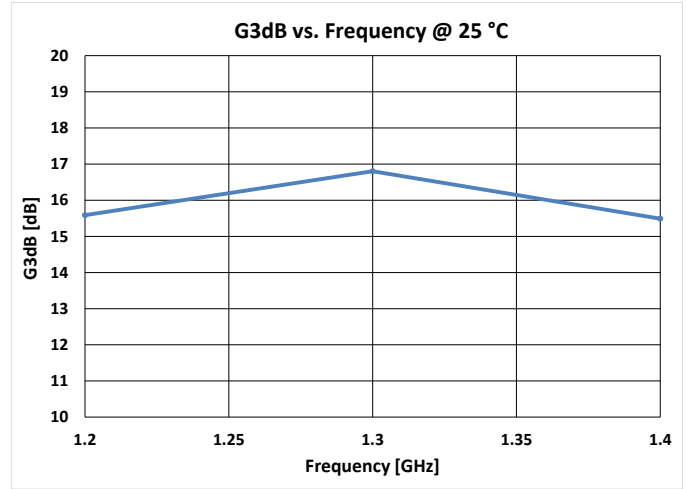
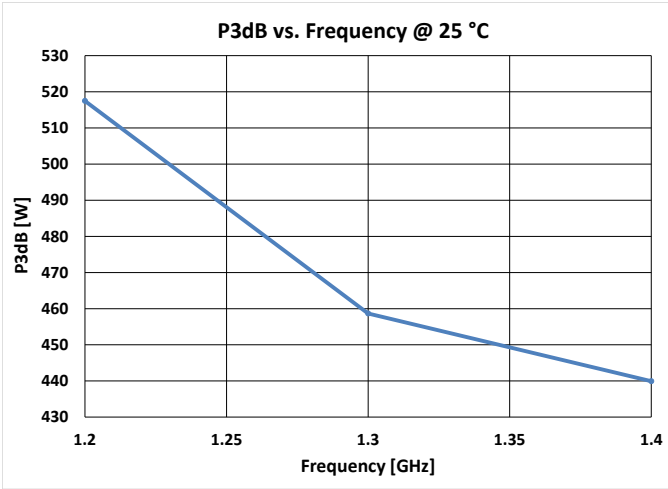

Pin Configuration and Description, and Package Marking¹

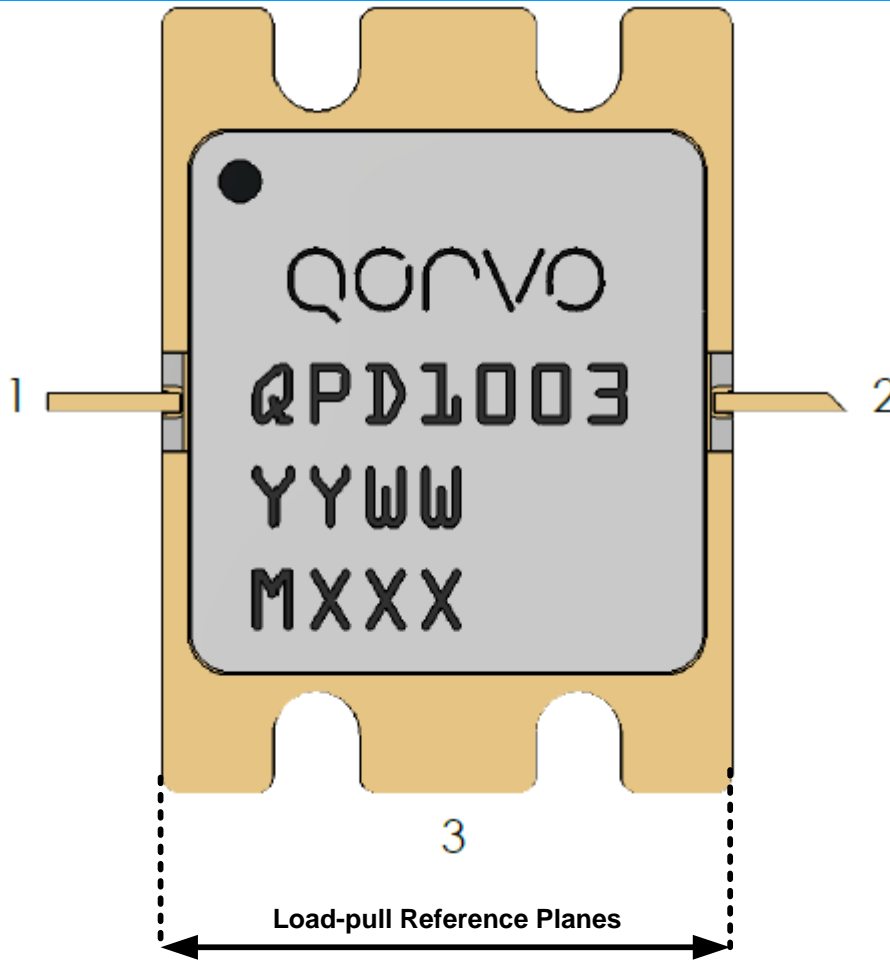

Pin Description

Pin	Symbol	Description
1	V_G / RF IN	Gate voltage / RF Input
2	V_D / RF OUT	Drain voltage / RF Output
3	GND	Package base / Ground

Notes:

- The QPD1003 will be marked with the “1003” designator and a lot code marked below the part designator. The “YY” represents the last two digits of the calendar year the part was manufactured, the “WW” is the work week of the assembly lot start, the “MXXX” is the production lot number.

Package Dimensions^{1, 2, 3}

- NOTES: UNLESS OTHERWISE SPECIFIED;
 1. PACKAGE IS AN ALL METAL DESIGN WITH CERAMIC LID AND FEED THRU'S.
 2. PACKAGE IS Ni/Au PLATED.
 3. PACKAGE IS EPOXY SEALED.
 4. ALL DIMENSIONS ARE IN MM.

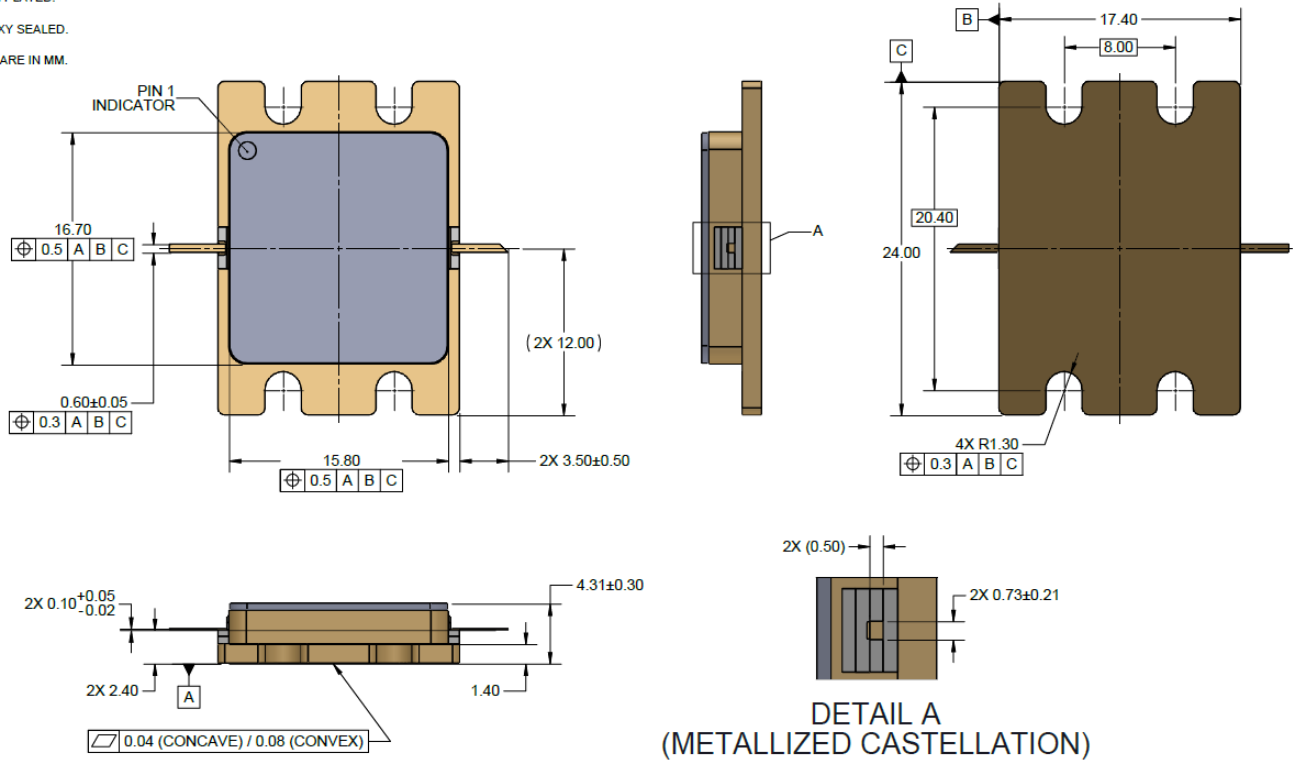

Notes:

1. Unless otherwise noted, the tolerance is ±0.15 mm.
2. For instruction to mount the part, please refer to application note "RF565 Package Mounting, Mechanical Mounting and PCB Considerations."

Schematic – 1.2 – 1.4 GHz EVB

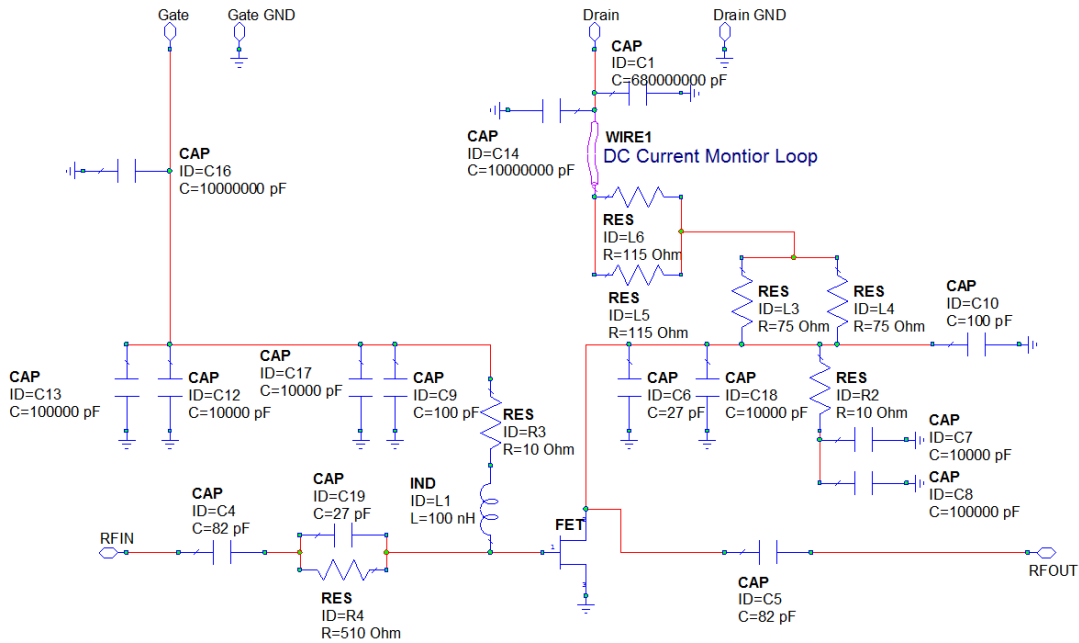

Bias-up Procedure	Bias-down Procedure
1. Set V_G to -4 V.	1. Turn off RF signal.
2. Set I_D current limit to 800 mA.	2. Turn off V_D
3. Apply 50 V V_D .	3. Wait 2 seconds to allow drain capacitor to discharge
4. Slowly adjust V_G until I_D is set to 750 mA.	4. Turn off V_G
5. Set I_D current limit to 2 A	
6. Apply RF.	

1.2 – 1.4 GHz EVB¹

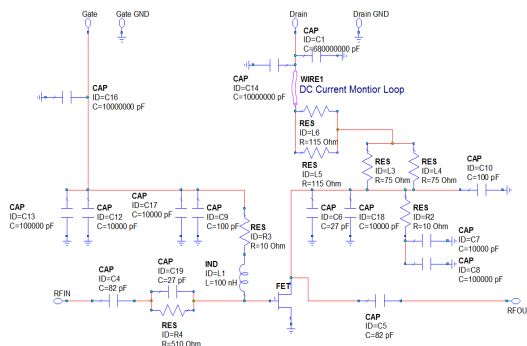
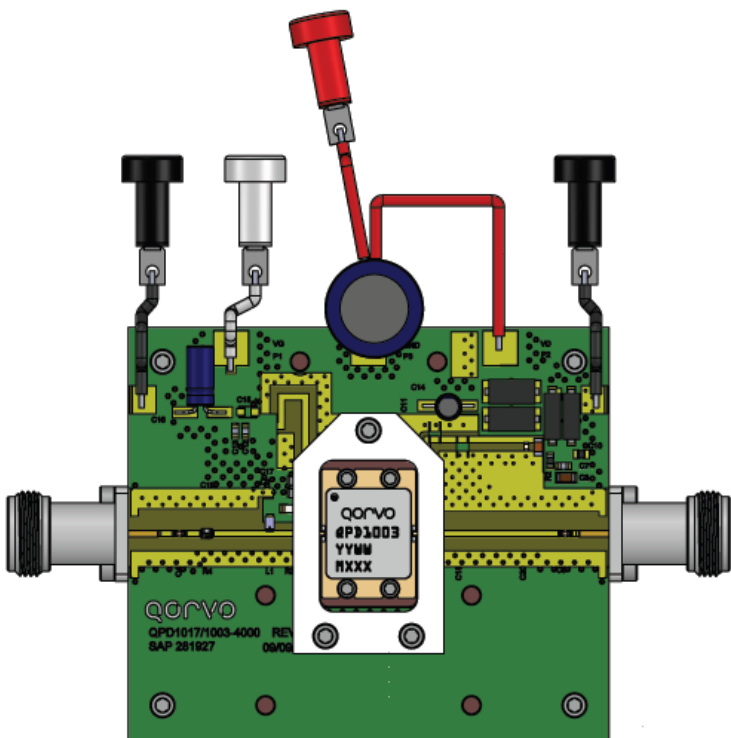

Notes:

1. PCB Material: RO4350B, 20 mil thickness, 1 oz copper cladding

Bill Of material – 1.2 – 1.4 GHz EVB

Ref Des	Value	Qty	Manufacturer	Part Number
C1	680 uF	1	Panasonic	EEU-FC2A681
C4, C5	82 pF	2	ATC	ATC600S820JT250XT
C9	1000 pF	1	Samsung	CL31B102KGFNFNE
C6, C19	27 pF	2	ATC	600S270JT250XT
C7, C12	10000 pF	2	Panasonic	ECJ-2VB2A103K
C8	0.1 uF	1	Panasonic	ECJ-3YB2A104K
C10	100 pF	1	ATC	ATC800A101JT250X
C13	0.1 uF	1	Kemet	C0805C104K5RACTU
C14, C16	10 uF	2	Panasonic	ECA-2AM100
C17, C18	10000 pF	2	Samsung	CL31B103KGFNFNE
R2	51 OHM	1	Panasonic	ERJ-6GEYJ510
R3	10 OHM	1	Panasonic	ERJ-8GEYJ100V
R4	510 OHM	1	Panasonic	ERJ-6GEYJ511
L1	100 nH	1	Coilcraft	0603LS-101XJLB
L3, L4	n/a	1	STEWART, INC.	35F0121-1SR-10
L5, L6	n/a	1	STEWART, INC.	28F0181-1SR-10

Recommended Solder Temperature Profile

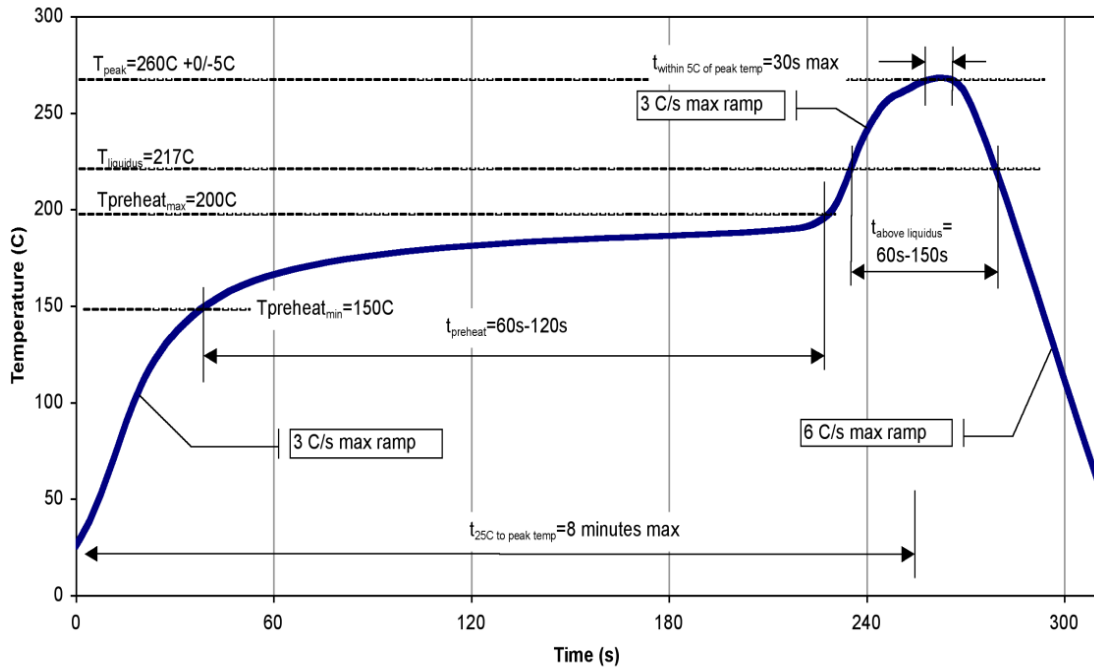

Handling Precautions

Parameter	Rating	Standard
ESD – Human Body Model (HBM)	Class 1B 950 V	ANSI/ESD/JEDEC JS-001
ESD – Charged Device Model (CDM)	Class C3 1000 V	ANSI/ESD/JEDEC JS-002
MSL – Moisture Sensitivity Level	MSL 3	IPC/JEDEC J-STD-020



Caution!
ESD-Sensitive Device

Solderability

Compatible with both lead-free (260°C max. reflow temp.) and tin/lead (245°C max. reflow temp.) soldering processes. Solder profiles available upon request.

Package lead plating is NiAu. Au thickness is 0.095 µm.

RoHS Compliance

This part is compliant with 2011/65/EU RoHS directive (Restrictions on the Use of Certain Hazardous Substances in Electrical and Electronic Equipment) as amended by Directive 2015/863/EU.

This product also has the following attributes:

- Halogen Free (Chlorine, Bromine)
- Antimony Free
- TBBP-A (C₁₅H₁₂Br₄O₂) Free
- PFOS Free
- SVHC Free

Contact Information

For the latest specifications, additional product information, worldwide sales and distribution locations:

Web: www.qorvo.com **Tel:** +1.844.890.8163
Email: customer.support@qorvo.com

For technical questions and application information: **Email:** info-products@qorvo.com

Important Notice

The information contained herein is believed to be reliable; however, Qorvo makes no warranties regarding the information contained herein and assumes no responsibility or liability whatsoever for the use of the information contained herein. All information contained herein is subject to change without notice. Customers should obtain and verify the latest relevant information before placing orders for Qorvo products. The information contained herein or any use of such information does not grant, explicitly or implicitly, to any party any patent rights, licenses, or any other intellectual property rights, whether with regard to such information itself or anything described by such information. **THIS INFORMATION DOES NOT CONSTITUTE A WARRANTY WITH RESPECT TO THE PRODUCTS DESCRIBED HEREIN, AND QORVO HEREBY DISCLAIMS ANY AND ALL WARRANTIES WITH RESPECT TO SUCH PRODUCTS WHETHER EXPRESS OR IMPLIED BY LAW, COURSE OF DEALING, COURSE OF PERFORMANCE, USAGE OF TRADE OR OTHERWISE, INCLUDING THE IMPLIED WARRANTIES OF MERCHANTABILITY AND FITNESS FOR A PARTICULAR PURPOSE.**

Without limiting the generality of the foregoing, Qorvo products are not warranted or authorized for use as critical components in medical, life-saving, or life-sustaining applications, or other applications where a failure would reasonably be expected to cause severe personal injury or death.

Copyright 2016 © Qorvo, Inc. | Qorvo is a registered trademark of Qorvo, Inc.