

HGTP20N36G3VL, HGT1S20N36G3VLS, HGT1S20N36G3VL

20A, 360V N-Channel,
Logic Level, Voltage Clamping IGBTs

March 2004

Features

- Logic Level Gate Drive
- Internal Voltage Clamp
- ESD Gate Protection
- $T_J = 175^\circ\text{C}$
- Ignition Energy Capable

Description

This N-Channel IGBT is a MOS gated, logic level device which is intended to be used as an ignition coil driver in automotive ignition circuits. Unique features include an active voltage clamp between the collector and the gate which provides Self Clamped Inductive Switching (SCIS) capability in ignition circuits. Internal diodes provide ESD protection for the logic level gate. Both a series resistor and a shunt resistor are provided in the gate circuit.

PACKAGING

PART NUMBER	PACKAGE	BRAND
HGTP20N36G3VL	TO-220AB	20N36GVL
HGT1S20N36G3VL	TO-262AA	20N36GVL
HGT1S20N36G3VLS	TO-263AB	20N36GVL

The development type number for this device is TA49296.

Packages

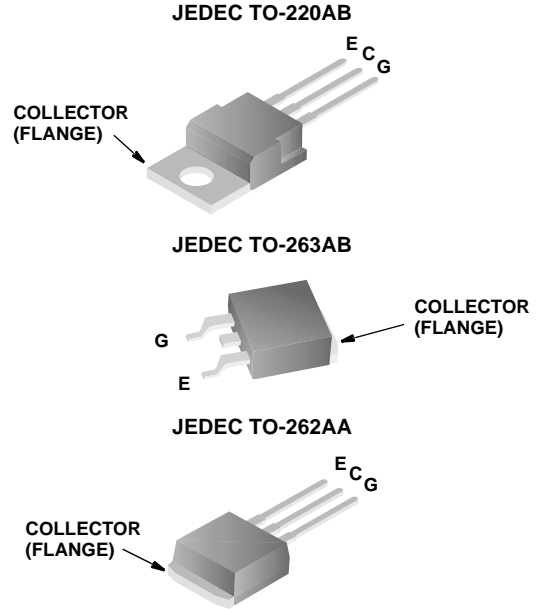

Symbol

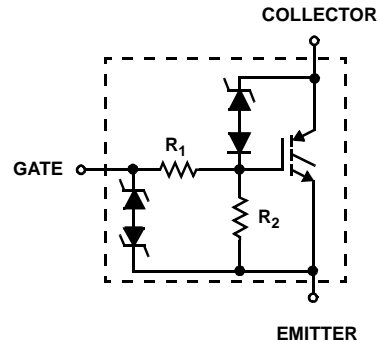

Absolute Maximum Ratings $T_C = +25^\circ\text{C}$, Unless Otherwise Specified

	HGTP20N36G3VL HGT1S20N36G3VL HGT1S20N36G3VLS	UNITS
Collector-Emitter Bkdn Voltage At 10mA, $R_{GE} = 1\text{k}\Omega$	395	V
Emitter-Collector Bkdn Voltage At 10mA	28	V
Collector Current Continuous At $V_{GE} = 5.0\text{V}$, $T_C = +25^\circ\text{C}$, Figure 7	37.7	A
At $V_{GE} = 5.0\text{V}$, $T_C = +100^\circ\text{C}$	26	A
Gate-Emitter-Voltage (Note)	± 10	V
Inductive Switching Current At $L = 2.3\text{mH}$, $T_C = +25^\circ\text{C}$	21	A
At $L = 2.3\text{mH}$, $T_C = +150^\circ\text{C}$	16	A
Collector to Emitter Avalanche Energy At $L = 2.3\text{mH}$, $T_C = +25^\circ\text{C}$	500	mJ
Power Dissipation Total At $T_C = +25^\circ\text{C}$	150	W
Power Dissipation Derating $T_C > +25^\circ\text{C}$	1.0	W/ $^\circ\text{C}$
Operating and Storage Junction Temperature Range	-40 to +175	$^\circ\text{C}$
Maximum Lead Temperature for Soldering	260	$^\circ\text{C}$
Electrostatic Voltage at 100pF, 1500 Ω	6	KV

NOTE: May be exceeded if I_{GEM} is limited to 10mA.

Specifications HGTP20N36G3VL, HGT1S20N36G3VL, HGT1S20N36G3VLS

Electrical Specifications $T_C = +25^\circ\text{C}$, Unless Otherwise Specified

PARAMETERS	SYMBOL	TEST CONDITIONS		LIMITS			UNITS
				MIN	TYP	MAX	
Collector-Emitter Breakdown Voltage	BV_{CES}	$I_C = 10\text{mA}$, $V_{GE} = 0\text{V}$	$T_C = +175^\circ\text{C}$	345	380	415	V
			$T_C = +25^\circ\text{C}$	355	385	415	V
			$T_C = -40^\circ\text{C}$	355	390	425	V
Collector-Emitter Breakdown Voltage	BV_{CER}	$I_C = 10\text{mA}$ $V_{GE} = 0\text{V}$ $R_{GE} = 1\text{k}\Omega$	$T_C = +175^\circ\text{C}$	320	360	395	V
			$T_C = +25^\circ\text{C}$	335	365	395	V
			$T_C = -40^\circ\text{C}$	335	370	410	V
Gate-Emitter Plateau Voltage	V_{GEP}	$I_C = 10\text{A}$ $V_{CE} = 12\text{V}$	$T_C = +25^\circ\text{C}$	-	3.7	-	V
Gate Charge	$Q_{G(ON)}$	$I_C = 10\text{A}$ $V_{GE} = 5\text{V}$ $V_{CE} = 12\text{V}$	$T_C = +25^\circ\text{C}$	-	28.7	-	nC
Collector-Emitter Clamp Breakdown Voltage	$BV_{CE(CL)}$	$I_C = 10\text{A}$ $R_G = 1\text{k}\Omega$	$T_C = +175^\circ\text{C}$	330	360	415	V
Emitter-Collector Breakdown Voltage	BV_{ECS}	$I_C = 10\text{mA}$	$T_C = +25^\circ\text{C}$	28	36	-	V
Collector-Emitter Leakage Current	I_{CES}	$V_{CE} = 250\text{V}$	$T_C = +25^\circ\text{C}$	-	-	5	μA
			$T_C = +175^\circ\text{C}$	-	-	250	μA
Emitter-Collector Leakage Current	I_{ECS}	$V_{EC} = 24\text{V}$	$T_C = +25^\circ\text{C}$	-	-	1.0	mA
Collector-Emitter Saturation Voltage	$V_{CE(SAT)}$	$I_C = 10\text{A}$ $V_{GE} = 4.5\text{V}$	$T_C = +25^\circ\text{C}$	-	1.3	1.6	V
			$T_C = +175^\circ\text{C}$	-	1.25	1.5	V
		$I_C = 20\text{A}$ $V_{GE} = 5.0\text{V}$	$T_C = +25^\circ\text{C}$	-	1.6	1.9	V
			$T_C = +175^\circ\text{C}$	-	1.9	2.4	V
Gate-Emitter Threshold Voltage	$V_{GE(TH)}$	$I_C = 1\text{mA}$ $V_{CE} = V_{GE}$	$T_C = +25^\circ\text{C}$	1.1	1.6	2.3	V
Gate Series Resistance	R_1		$T_C = +25^\circ\text{C}$	-	75	-	Ω
Gate-Emitter Resistance	R_2		$T_C = +25^\circ\text{C}$	10	20	30	k Ω
Gate-Emitter Leakage Current	I_{GES}	$V_{GE} = \pm 10\text{V}$		± 330	± 500	± 1000	μA
Gate-Emitter Breakdown Voltage	BV_{GES}	$I_{GES} = \pm 2\text{mA}$		± 12	± 14	-	V
Current Turn-Off Time-Inductive Load	$t_{D(OFF)} + t_{F(OFF)}$	$I_C = 10\text{A}$, $R_G = 25\Omega$, $L = 550\mu\text{H}$, $R_L = 26.4\Omega$, $V_{GE} = 5\text{V}$, $V_{CL} = 300\text{V}$, $T_C = +175^\circ\text{C}$		-	15	30	μs
Inductive Use Test	I_{SCIS}	$L = 2.3\text{mH}$, $V_G = 5\text{V}$, $R_G = 1\text{k}\Omega$	$T_C = +150^\circ\text{C}$	16	-	-	A
			$T_C = +25^\circ\text{C}$	21	-	-	A
Thermal Resistance	$R_{\theta JC}$			-	-	1.0	$^\circ\text{C/W}$

Typical Performance Curves

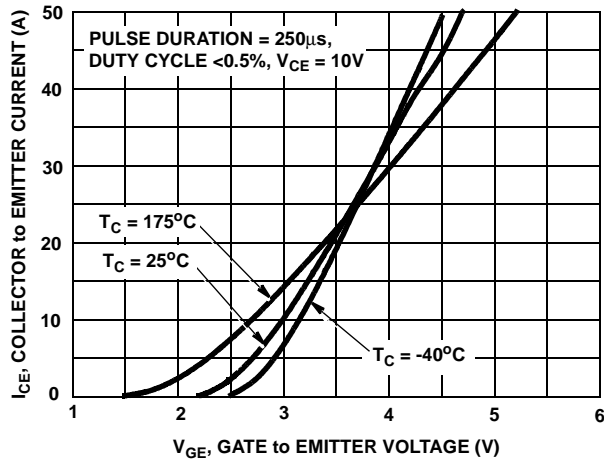

FIGURE 1. TRANSFER CHARACTERISTICS

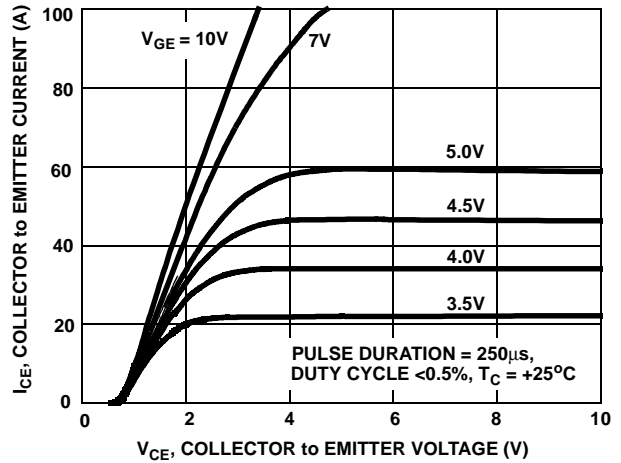

FIGURE 2. SATURATION CHARACTERISTICS

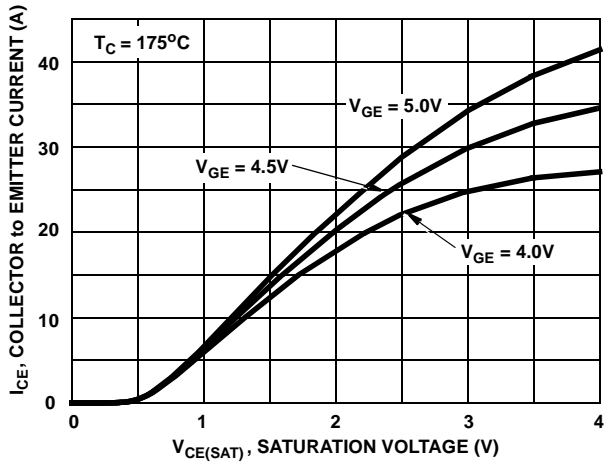

FIGURE 3. COLLECTOR to EMITTER CURRENT vs SATURATION VOLTAGE

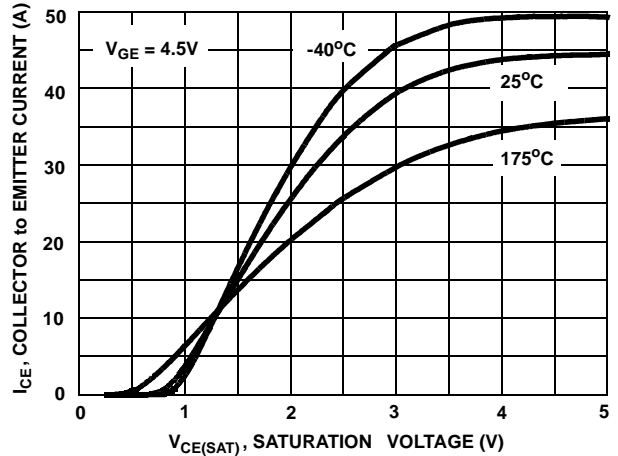

FIGURE 4. COLLECTOR to EMITTER CURRENT vs SATURATION VOLTAGE

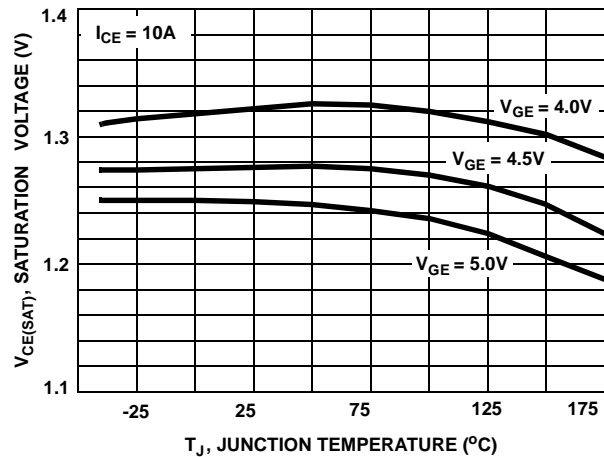

FIGURE 5. SATURATION VOLTAGE vs JUNCTION TEMPERATURE

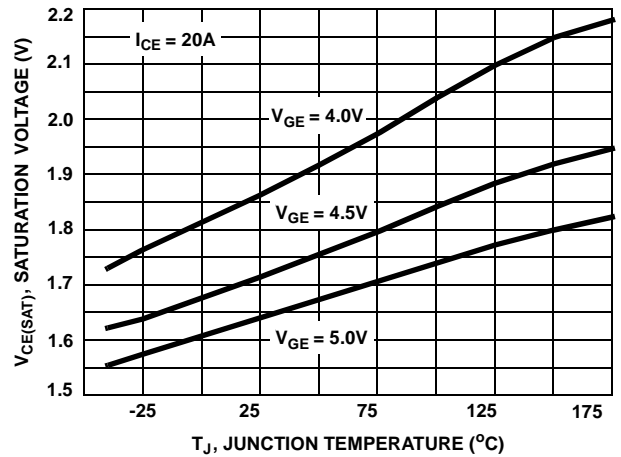

FIGURE 6. SATURATION VOLTAGE vs JUNCTION TEMPERATURE

Typical Performance Curves (Continued)

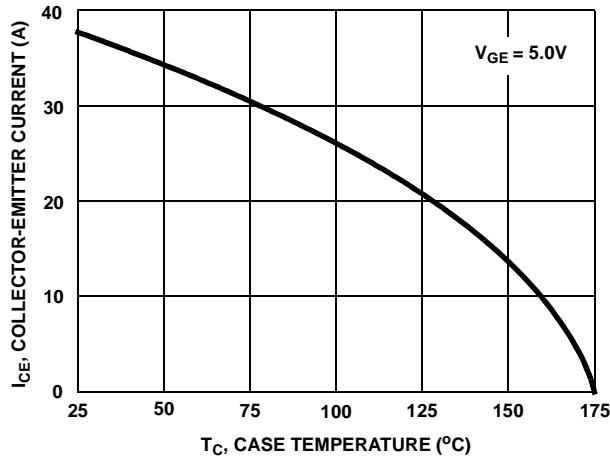

FIGURE 7. COLLECTOR-EMITTER CURRENT vs CASE TEMPERATURE

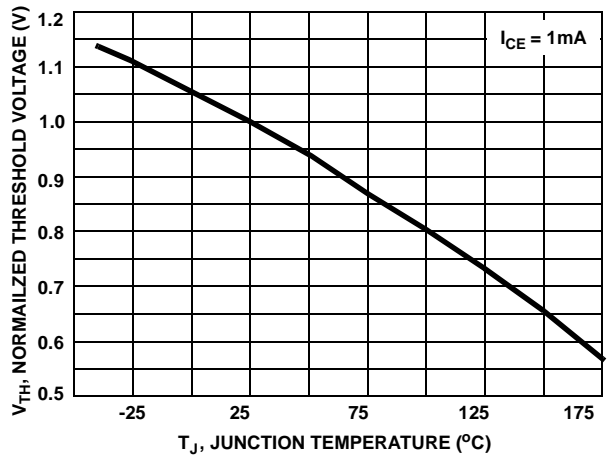

FIGURE 8. NORMALIZED THRESHOLD VOLTAGE vs JUNCTION TEMPERATURE

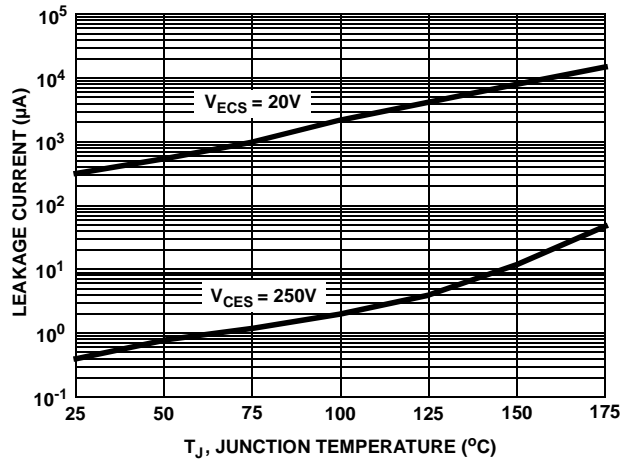

FIGURE 9. LEAKAGE CURRENT vs JUNCTION TEMPERATURE

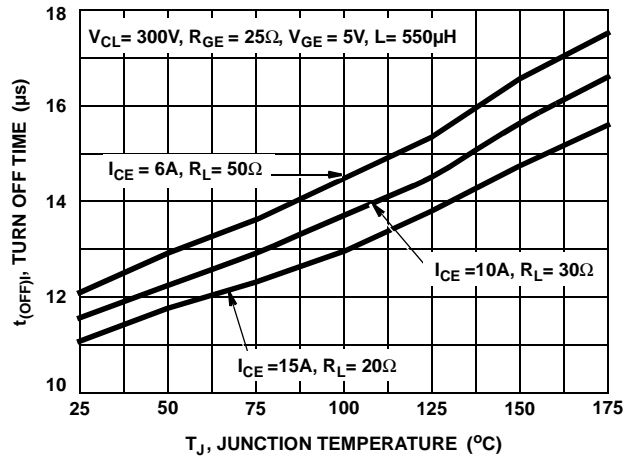

FIGURE 10. TURN-OFF TIME vs JUNCTION TEMPERATURE

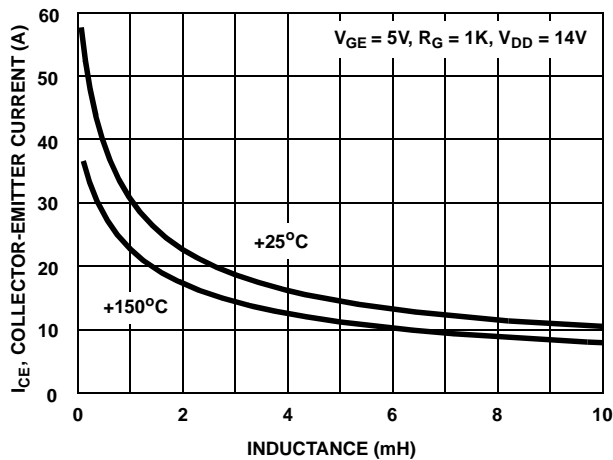

FIGURE 11. SELF CLAMPED INDUCTIVE SWITCHING CURRENT vs INDUCTANCE

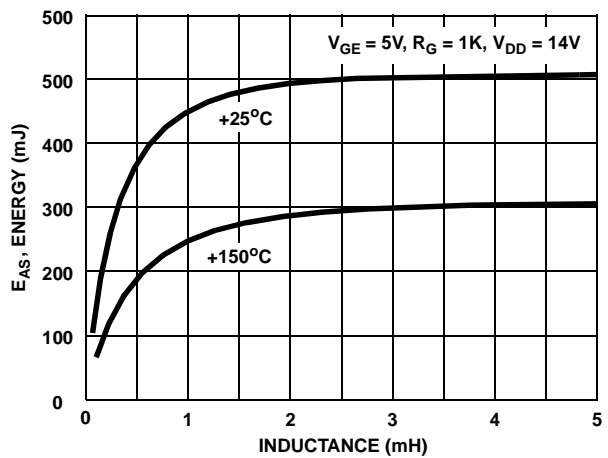

FIGURE 12. SELF CLAMPED INDUCTIVE SWITCHING ENERGY vs INDUCTANCE

Typical Performance Curves (Continued)

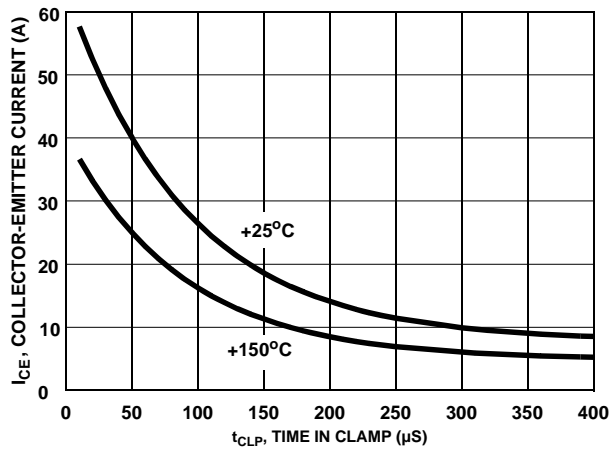

FIGURE 13. SELF CLAMPED INDUCTIVE SWITCHING CURRENT vs TIME IN CLAMP

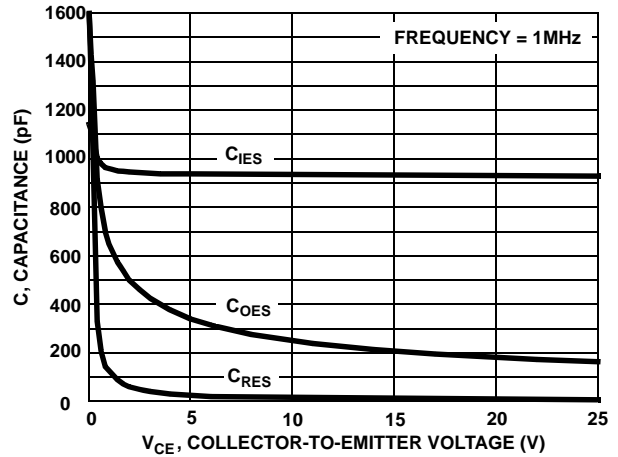

FIGURE 14. CAPACITANCE vs COLLECTOR-EMITTER VOLTAGE

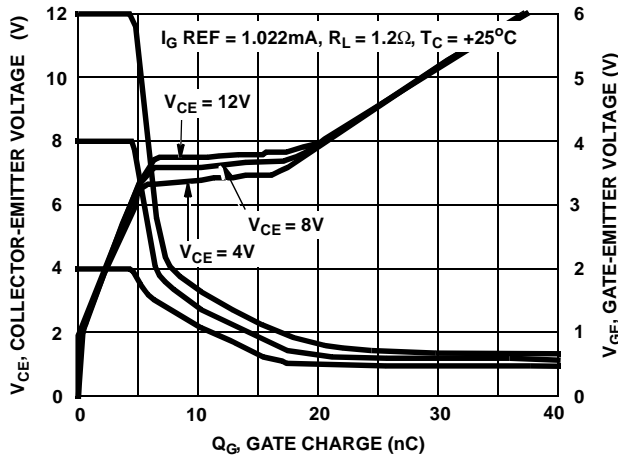

FIGURE 13. GATE CHARGE

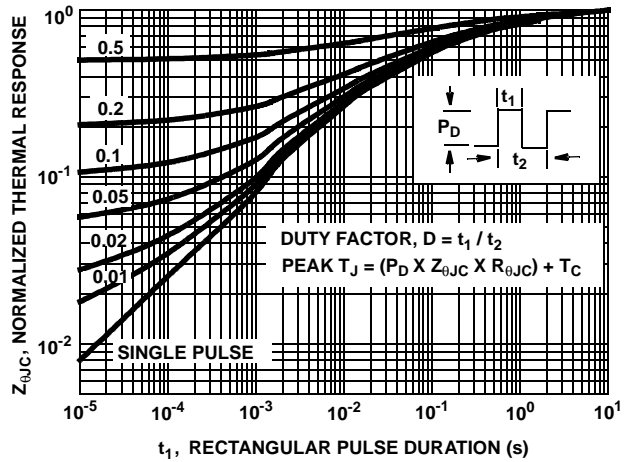

FIGURE 14. NORMALIZED TRANSIENT THERMAL IMPEDANCE, JUNCTION TO CASE

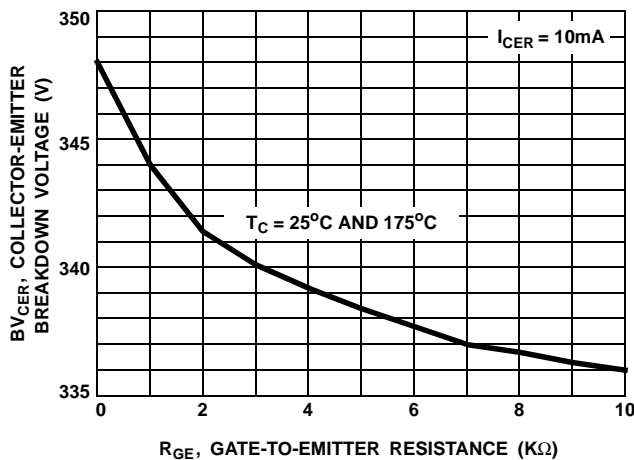

FIGURE 15. BREAKDOWN VOLTAGE vs GATE-EMITTER RESISTANCE

Test Circuits

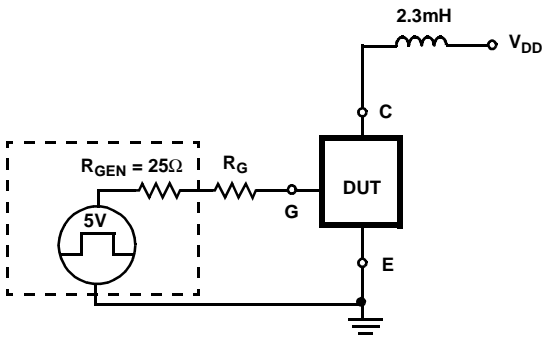

FIGURE 16. USE TEST CIRCUIT

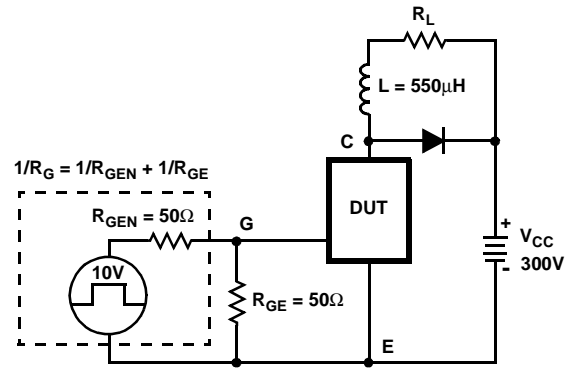

FIGURE 17. INDUCTIVE SWITCHING TEST CIRCUIT

TRADEMARKS

The following are registered and unregistered trademarks Fairchild Semiconductor owns or is authorized to use and is not intended to be an exhaustive list of all such trademarks.

ACEx™	FACT Quiet Series™	ISOPLANAR™	POP™	Stealth™
ActiveArray™	FAST®	LittleFET™	Power247™	SuperFET™
Bottomless™	FASTr™	MICROCOUPLER™	PowerSaver™	SuperSOT™-3
CoolFET™	FPST™	MicroFET™	PowerTrench®	SuperSOT™-6
CROSSVOLT™	FRFET™	MicroPak™	QFET®	SuperSOT™-8
DOMET™	GlobalOptoisolator™	MICROWIRE™	QS™	SyncFET™
EcoSPARK™	GTO™	MSX™	QT Optoelectronics™	TinyLogic®
E ² CMOS™	HiSeC™	MSXPro™	Quiet Series™	TINYOPTO™
EnSigna™	µC™	OCX™	RapidConfigure™	TruTranslation™
FACT™	ImpliedDisconnect™	OCXPro™	RapidConnect™	UHC™
Across the board. Around the world.™	OPTOLOGIC®	OPTOPLANAR™	SILENT SWITCHER®	UltraFET®
The Power Franchise®	OPTOPLANAR™	SMART START™	SPM™	VCX™
Programmable Active Droop™	PACMAN™			

DISCLAIMER

FAIRCHILD SEMICONDUCTOR RESERVES THE RIGHT TO MAKE CHANGES WITHOUT FURTHER NOTICE TO ANY PRODUCTS HEREIN TO IMPROVE RELIABILITY, FUNCTION OR DESIGN. FAIRCHILD DOES NOT ASSUME ANY LIABILITY ARISING OUT OF THE APPLICATION OR USE OF ANY PRODUCT OR CIRCUIT DESCRIBED HEREIN; NEITHER DOES IT CONVEY ANY LICENSE UNDER ITS PATENT RIGHTS, NOR THE RIGHTS OF OTHERS.

LIFE SUPPORT POLICY

FAIRCHILD'S PRODUCTS ARE NOT AUTHORIZED FOR USE AS CRITICAL COMPONENTS IN LIFE SUPPORT DEVICES OR SYSTEMS WITHOUT THE EXPRESS WRITTEN APPROVAL OF FAIRCHILD SEMICONDUCTOR CORPORATION. As used herein:

1. Life support devices or systems are devices or systems which, (a) are intended for surgical implant into the body, or (b) support or sustain life, or (c) whose failure to perform when properly used in accordance with instructions for use provided in the labeling, can be reasonably expected to result in significant injury to the user.
2. A critical component is any component of a life support device or system whose failure to perform can be reasonably expected to cause the failure of the life support device or system, or to affect its safety or effectiveness.

PRODUCT STATUS DEFINITIONS

Definition of Terms

Datasheet Identification	Product Status	Definition
Advance Information	Formative or In Design	This datasheet contains the design specifications for product development. Specifications may change in any manner without notice.
Preliminary	First Production	This datasheet contains preliminary data, and supplementary data will be published at a later date. Fairchild Semiconductor reserves the right to make changes at any time without notice in order to improve design.
No Identification Needed	Full Production	This datasheet contains final specifications. Fairchild Semiconductor reserves the right to make changes at any time without notice in order to improve design.
Obsolete	Not In Production	This datasheet contains specifications on a product that has been discontinued by Fairchild semiconductor. The datasheet is printed for reference information only.