

# Quick Start Guide (QSG) for

- FRDM-KEAZ128
- FRDM-KEAZ64
- FRDM-KEAZN32

Ultra-Reliable MCUs for Industrial and Automotive

[www.freescale.com/FRDM-KEA](http://www.freescale.com/FRDM-KEA)



## Contents:

- [Quick Start Package](#)
- [Get to Know FRDM-KEA](#)
- [FRDM-KEA Features](#)
- [Pinout and Jumper Settings](#)
- [Out of the Box Setup using S32 Design Studio](#)
- [Out of the Box Setup using KDS](#)
- [Code Examples](#)
- [Documentation and Enablement](#)
- [SDK Drivers](#)
- [Feature Comparison for KEA Family](#)
- [Introduction to OpenSDA](#)

# Quick Start Package Overview

Name	Type	Description
Quick Start Guide	PDF	This document
Precompiled Examples	Folder	S-record images of example projects for use with the MSD Flash
SDK Evaluation Drivers	Folder	Headers and source code drivers, driver summary and testing

Additional reference documents are available on [www.freescale.com/FRDM-KEAZ128](http://www.freescale.com/FRDM-KEAZ128)

Name	Description
FRDM-KEA Quick Start Package	Quick Start Guide and supporting files for getting started with the FRDM-KEA
FRDM-KEA User's Guide	This document— Overview and detailed information for the FRDM-KEA hardware
FRDM-KEA Pinouts	Spreadsheet of pin connections for all MCU pins. Includes pinout for the I/O headers, Arduino™ R3 compatibility chart, and OpenSDA MCU pinout.
FRDM-KEA Schematics	PDF and Gerber schematic files for the FRDM-KEA hardware
FRDM-KEA Design Package	Zip file containing all design source files for the FRDM-KEA hardware
OpenSDA User's Guide	Overview and instructions for use of the OpenSDA embedded debug circuit

# NXP Get to know the FRDM-KEAZ128

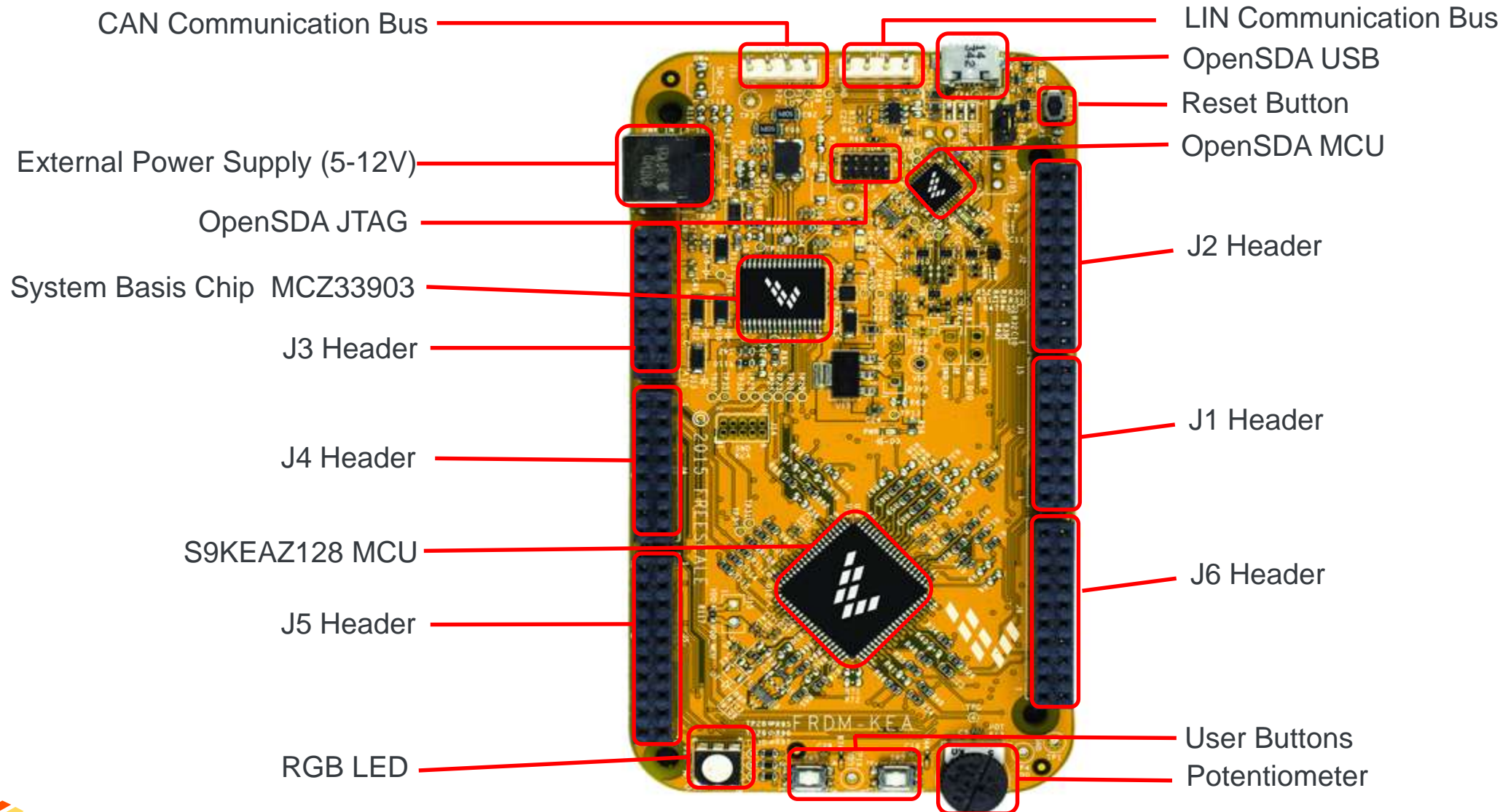



# Features of FRDM-KEA:

- Supports **KEAZ128, KEAZ64 and KEAZN32 MCUs**
  - KEA is 5V, qualified to Automotive Grade 1 and -40 to +125 °C
- Small form factor size supports up to 6" x 4"
- Platform supports scalability up to 176 pins
- Arduino™ UNO footprint-compatible with expansion “shield” support
- Integrated open-standard serial and debug adapter (OpenSDA) with support for several industry-standard debug interfaces
- Easy access to the MCU I/O header pins for prototyping
- On-chip connectivity for CAN, LIN, UART/SCI and SPI
- Potentiometer for precise voltage and analog measurement
- RGB LED
- Two push-button switches (SW2 and SW3)
- Flexible power supply options
  - microUSB or
  - external 12V power supply
- Similar hardware across ARM®, S12 and Power Architecture® architecture based MCUs

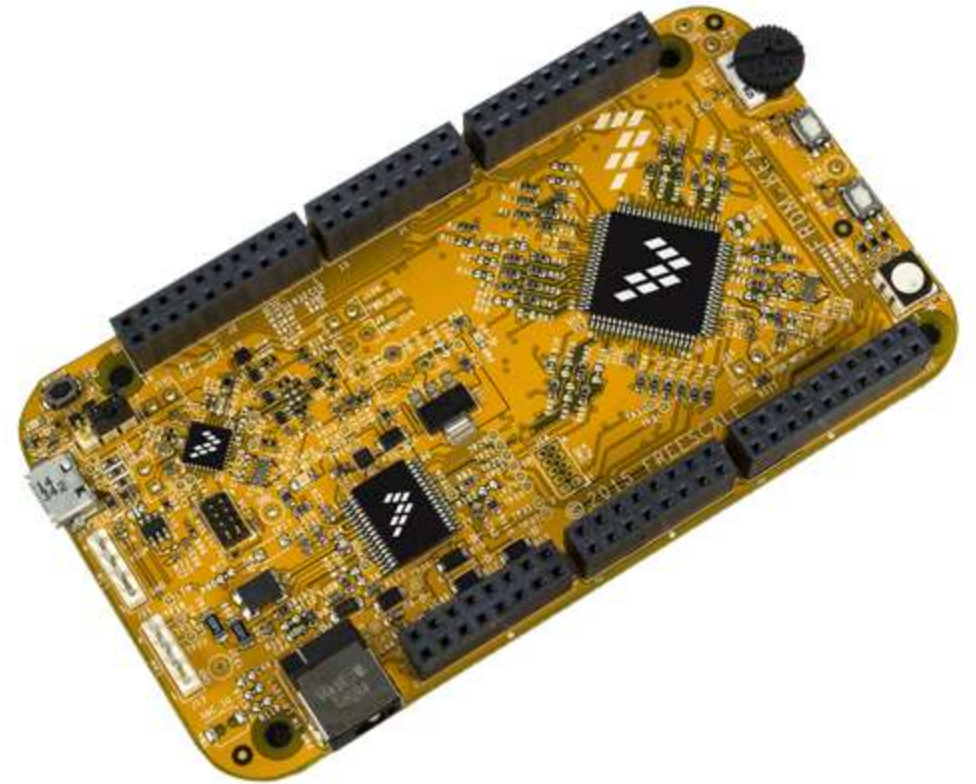

## Includes:

- Freescale Freedom board
- USB cable
- URL to online Quick Start Guide (QSG)
- Complimentary IDE Software
  - KDS and S32 Design Studio

# Header/Pinout Mapping for FRDM-KEAZ128

PIN	PORT	FUNCTION	J3	PIN	PORT	FUNCTION
J3-01		VIN		J3-02	PTB6*	GPIO
J3-03		IOREF		J3-04	PTB7*	GPIO
J3-05	PTA5	RESET_TGTMCU		J3-06	PTE0	GPIO
J3-07		P3V3		J3-08	PTE1	GPIO
J3-09		5V		J3-10	PTE2	GPIO
J3-11		GND		J3-12	PTE3	GPIO
J3-13		GND		J3-14	PTE4	GPIO
J3-15		VIN		J3-16	PTE5	GPIO

PIN	PORT	FUNCTION	J4	PIN	PORT	FUNCTION
J4-01	PTC0	ADC0		J4-02	PTF1	GPIO
J4-03	PTC1	ADC1		J4-04	PTC4	GPIO
J4-05	PTF4	ADC2		J4-06	PTC5	GPIO
J4-07	PTF5	ADC3		J4-08	PTE6	GPIO
J4-09	PTF6	ADC4		J4-10	PTH0	GPIO
J4-11	PTF7	ADC5		J4-12	PTE7	GPIO
J4-13	PTA0	ADC6		J4-14	PTH6	GPIO
J4-15	PTA1	ADC7		J4-16	PTH7	GPIO

PIN	PORT	FUNCTION	J5	PIN	PORT	FUNCTION
J5-01	PTC2	ADC8		J5-02	PTF2	GPIO
J5-03	PTC3	ADC9		J5-04	PTF3	GPIO
J5-05	PTB3	ADC10		J5-06	PTI2	GPIO
J5-07	PTA6	ADC11		J5-08	PTI3	GPIO
J5-09	PTA7	ADC12		J5-10		VDD
J5-11	PTB0	ADC13		J5-12		GND
J5-13	PTB1	ADC14		J5-14	PTI4	GPIO
J5-15	PTB2	ADC15		J5-16	PTI5	GPIO
J5-17		NC		J5-18	PTI6	GPIO
J5-19		SBC_SAFE		J5-20	PTH5	GPIO

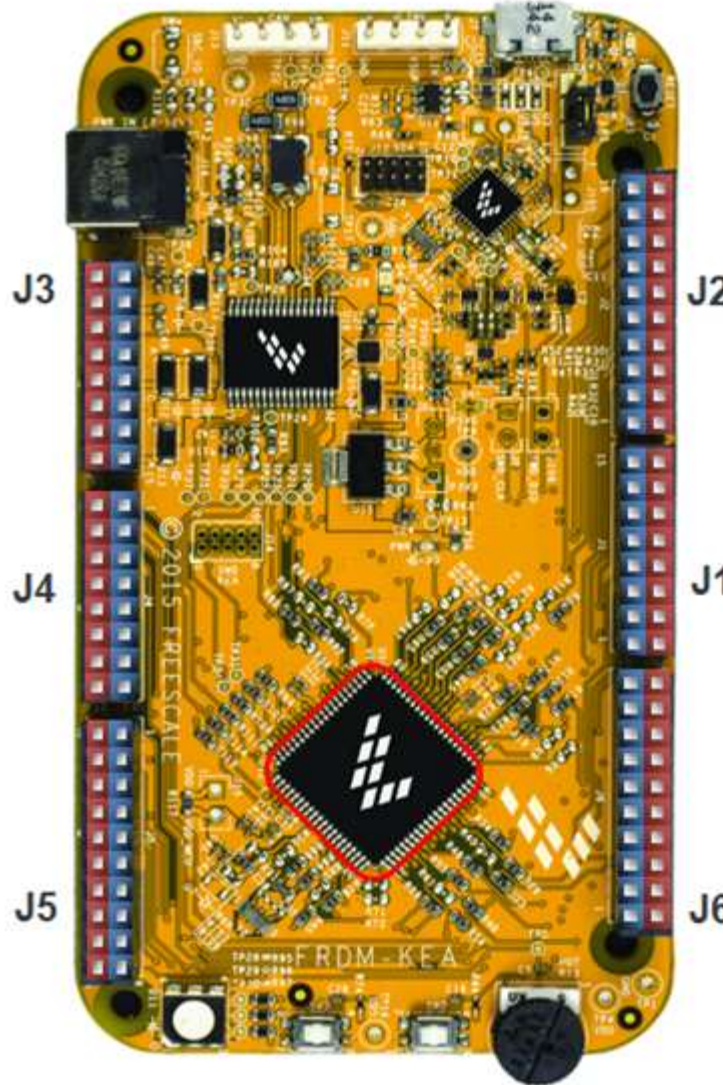

PIN	PORT	FUNCTION	J2	PIN	PORT	FUNCTION
J2-19	PTA3	D15		J2-20	PTG3	GPIO
J2-17	PTA2	D14		J2-18	PTG2	GPIO
J2-15		A REF		J2-16	PTG1	GPIO
J2-13		GND		J2-14	PTG0	GPIO
J2-11	PTB2	D13		J2-12	PTF0	GPIO
J2-09	PTB4	D12		J2-10	PTH1	GPIO
J2-07	PTB3	D11		J2-08	PTC2	GPIO
J2-05	PTB5	D10		J2-06	PTC3	GPIO
J2-03	PTH2	D9		J2-04	PTB4	GPIO
J2-01	PTC5	D8		J2-02	PTB5	GPIO

PIN	PORT	FUNCTION	J1	PIN	PORT	FUNCTION
J1-15	PTG7	D7		J1-16	PTA4	GPIO
J1-13	PTG6	D6		J1-14	PTA1	GPIO
J1-11	PTG5	D5		J1-12	PTD7	GPIO
J1-09	PTG4	D4		J1-10	PTD6	GPIO
J1-07	PTH1	D3		J1-08	PTD5	GPIO
J1-05	PTF0	D2		J1-06	PTD4	GPIO
J1-03	PTB1	D1		J1-04	PTD3	GPIO
J1-01	PTB0	D0		J1-02	PTD2	GPIO

PIN	PORT	FUNCTION	J6	PIN	PORT	FUNCTION
J6-19	PTC7	D14		J6-20		NC
J6-17	PTC6	D15		J6-18		NC
J6-15	PTI1	D16		J6-16		NC
J6-13	PTI0	D17		J6-14		NC
J6-11	PTF3	D18		J6-12		GND
J6-09	PTF2	D19		J6-10		VDD
J6-07	PTH3	D20		J6-08	PTH2	GPIO
J6-05	PTH4	D21		J6-06	PTE7	GPIO
J6-03	PTD1	GPIO		J6-04	PTD3	GPIO
J6-01	PTD0	GPIO		J6-02	PTD2	GPIO

\* For pin multiplex options please review pinmap file



# Jumper Settings for FRDM-KEAZ128

There is only one jumper: J104  
It is to select Reset source:

1-2: **Default**

2-3: **Reset** signal direct to the MCU  
when OpenSDA is not powered



# NXP Package Level Pinout Diagram – KEAZ128 (80 LQFP)

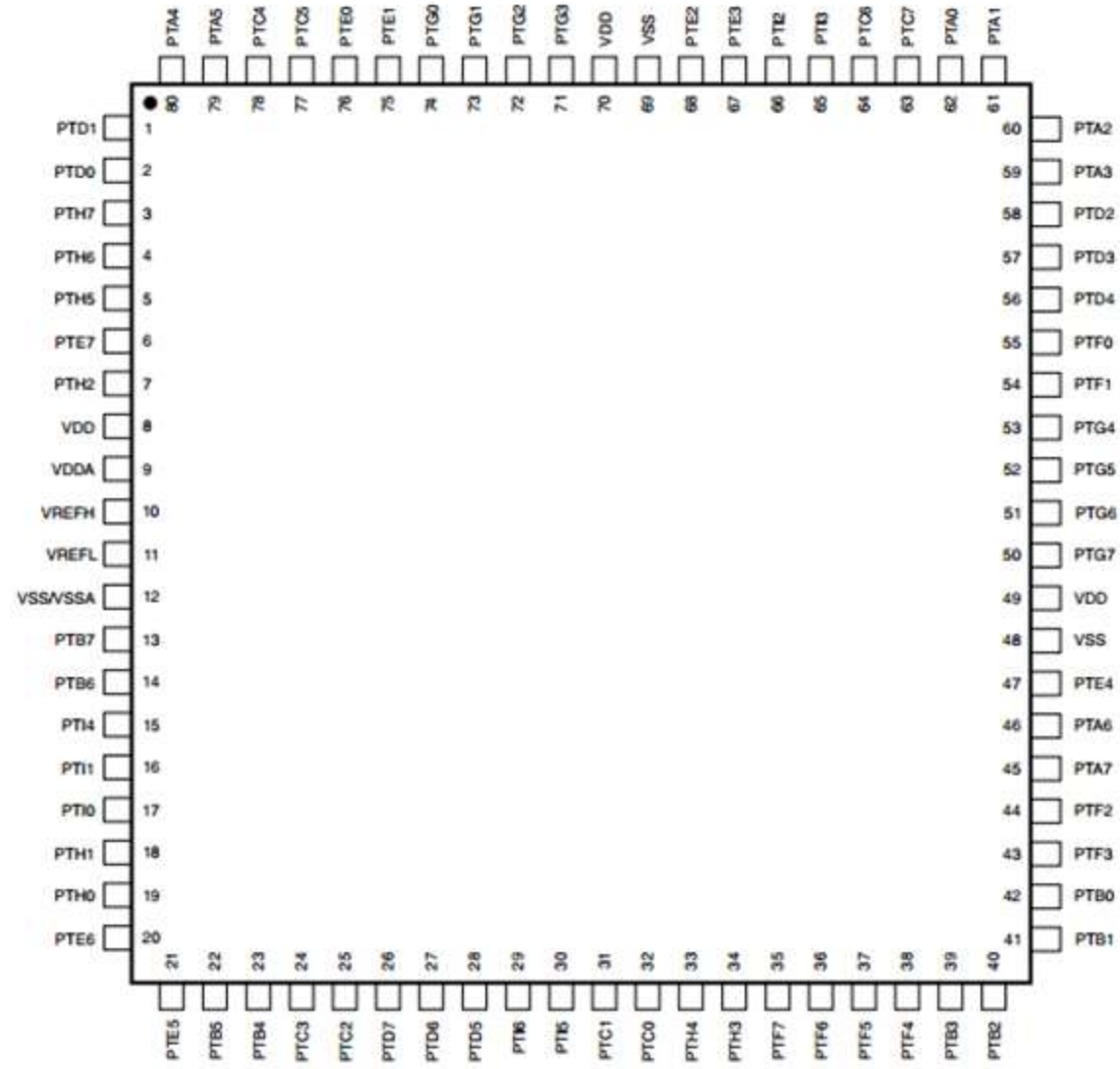





# Package Level Pinout Diagram – KEAZ64 (64 LQFP)

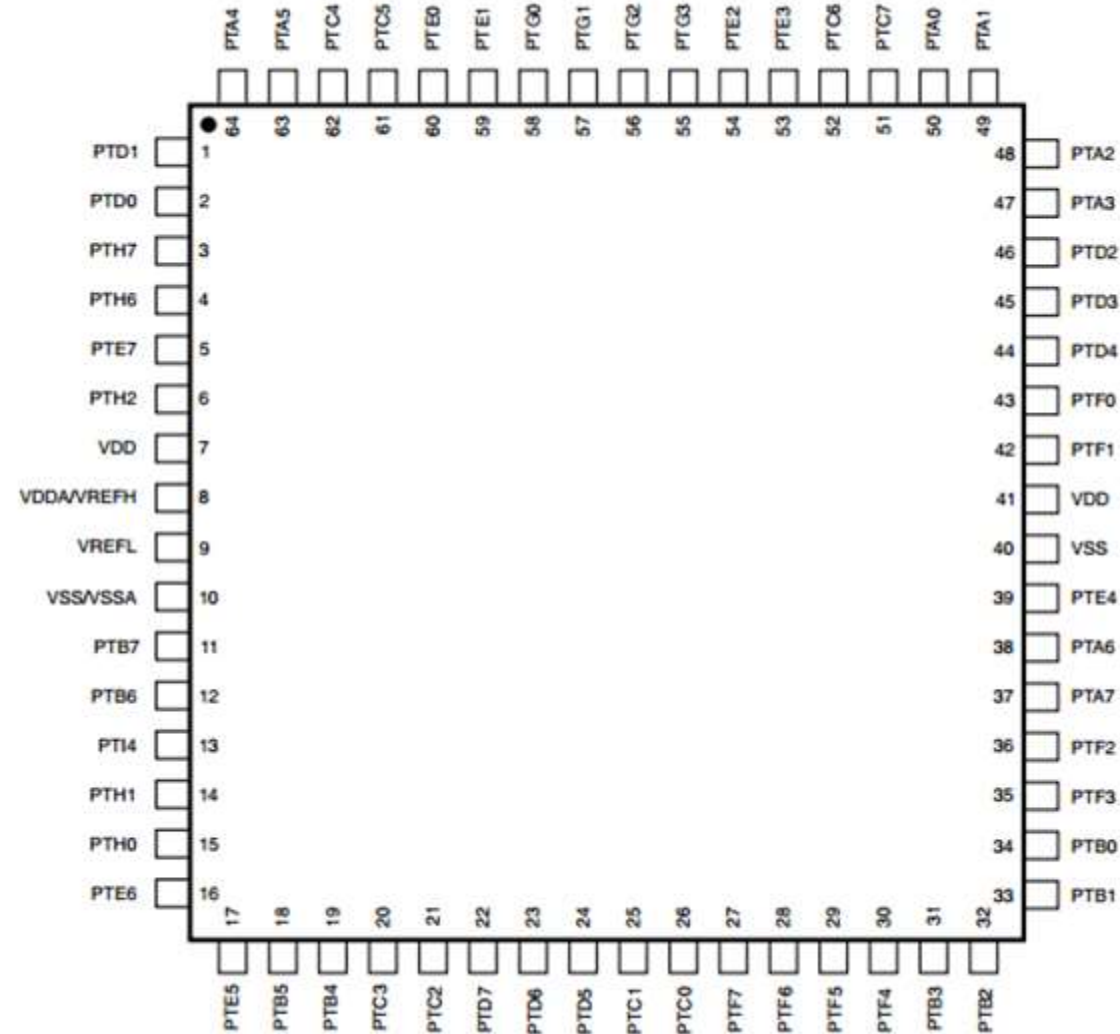

# NXP Package Level Pinout Diagram – KEAZN32 (64 LQFP)

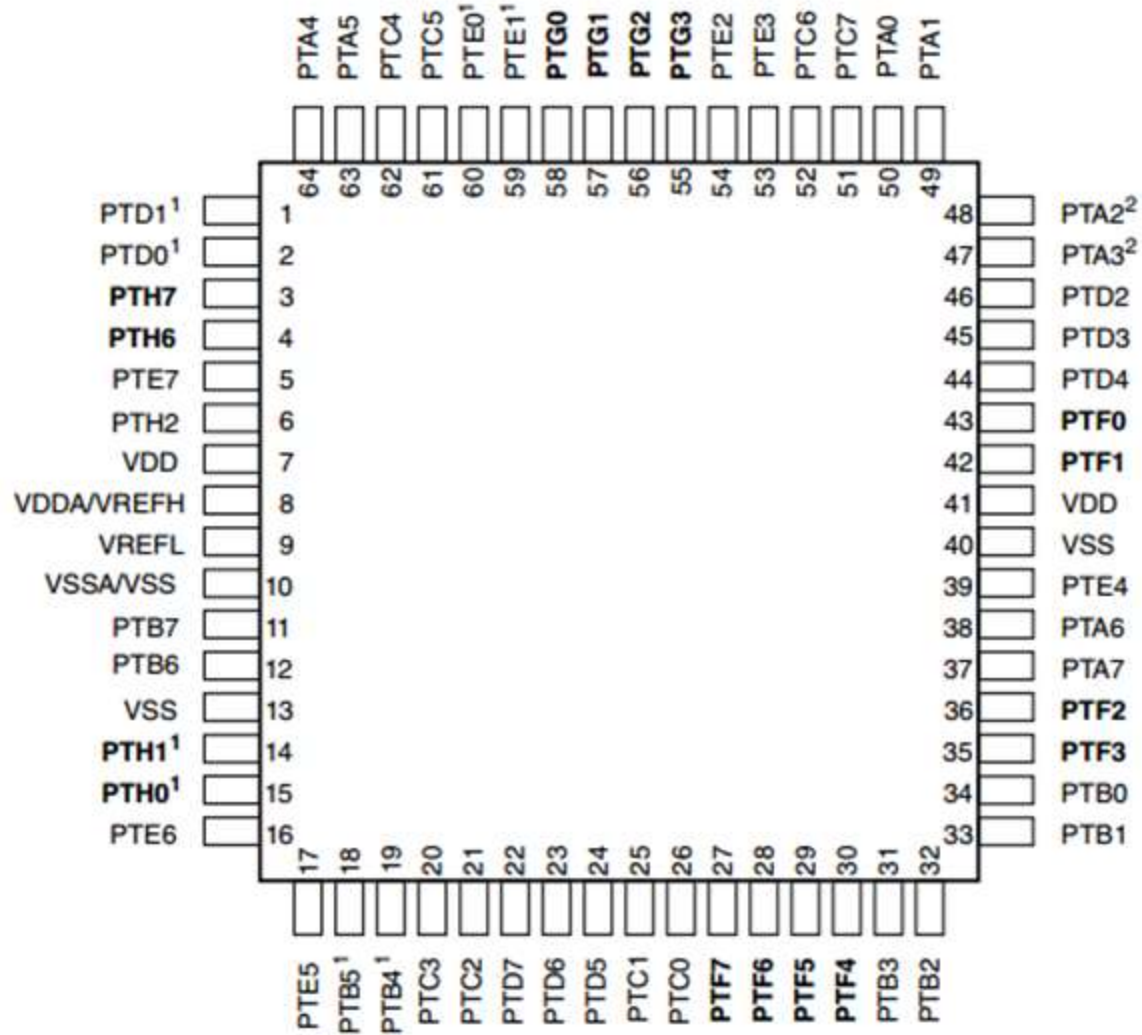

# Step-by-Step Setup Instructions for S32 Design Studio IDE

In this quick start guide, you will learn how to setup the **FRDM-KEA** board with pre-loaded code example



1

## Install Software and Tools

Install **S32 Design Studio for ARM MCUs V1.x** at [S32 Design Studio for ARM v1.0 for Windows](#) or [www.freescale.com/s32ds](http://www.freescale.com/s32ds)  
Download the **Software Installation Guide for S32DS** which provides step by step installation instructions

2

## Power up FRDM-KEA Board

Follow step by step power and setup procedures on slides 12-14

3

## Run the Pre-loaded Code Examples

Run the pre-loaded 2-in-1 code example project which utilizes the **FRDM-KEA** potentiometer and the RGB LED.  
**Follow slides 15-16 to switch between code example #1 and #2**  
*\* To get back to Code example #1 press SW3 button*

4

## Learn More About the KEA

Install **FreeMaster - free serial real-time GUI monitor tool**  
follow slides 32-46 from the Software Installation Guide

Read the release notes and documentation on [www.freescale.com/KEA](http://www.freescale.com/KEA)



# Step-by-Step Setup Instructions for **Kinetis Design Studio (KDS) IDE**

In this quick start guide, you will learn how to setup the **FRDM-KEAZ128** board with pre-loaded code example

**1**

## Install Software and Tools

Install Kinetis Design Studio Integrated Development Environment (IDE)  
[www.freescale.com/kds](http://www.freescale.com/kds)

**2**

## Connect the USB Cable

Follow step by step power and setup procedures on slides 12-14

**3**

## Using the Pre-loaded Code Example Project

Run the pre-loaded 2-in-1 code example project which utilizes the **FRDM-KEA** potentiometer and the RGB LED.

**Follow slides 15-16 to switch between code example #1 and #2**

*\* To get back to Code example #1 press SW3 button*

**4**

## Learn More About the KEA

**Install FreeMaster - free serial real-time GUI monitor tool**  
follow slides 32-46 from the Software Installation Guide

Read the release notes and documentation on [www.freescale.com/KEA](http://www.freescale.com/KEA)

## Step 1: Power up the Board – FRDM-KEA Power Supplies

- The FRDM-KEA evaluation board powers from a USB or external 12V power supply
- Connect the USB cable to a PC using supplied USB cable or plug it into a socket (12V power supply sold separately)
  - External power port is J16
  - Only use one power supply, not both
- Connect other end of USB cable (microUSB) to mini-B port on FRDM-KEA at J7
- Allow the PC to automatically configure the USB drivers if needed
- Debug is done using OpenSDA through J7

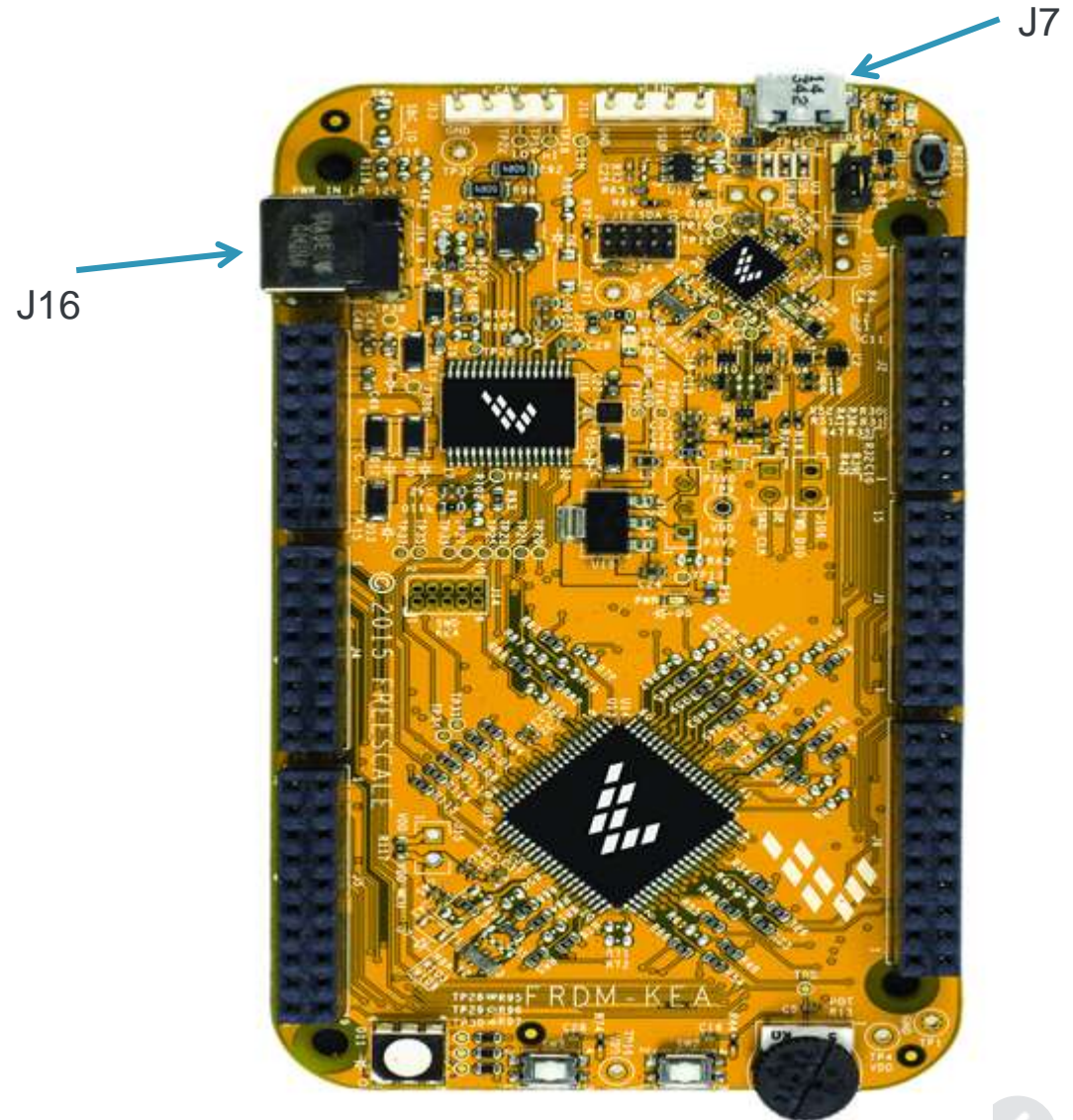

## Step 1: Power up the Board – Is it powered on correctly?

- When powered through USB, LEDs D2 and D3 should light green
- FRDM-KEA boards ship with a 2-in-1 demo code example pre-installed
- When you power the board, it will default to the Blinking LED demo
- The RGB LED D11 will blink
- If you see this initially when powered, the correct firmware is running





## Step 1: Power up the Board – Is it powered on correctly?

- Switch between code example projects using push buttons SW2 and SW3
- The buttons are located on the edge of the board opposite the microUSB port.



SW3

SW2

## Step 2: Running Code Example #1 (Blinking LED Demo)

**Code Example #1 allows D11 (RGB LED) to illuminate in response to turning R13 (Potentiometer). The LED color will change as the potentiometer position is adjusted**

- The Blinking LED Demo uses ADC and FTM
- FTM interrupts toggles the RGB LED D11 at a frequency controlled by the value of the ADC
- ADC controls the blink period and LED selection (red, green, or blue)
- Dialing the potentiometer R13 will cause D11 to change frequency or color depending on the resistance

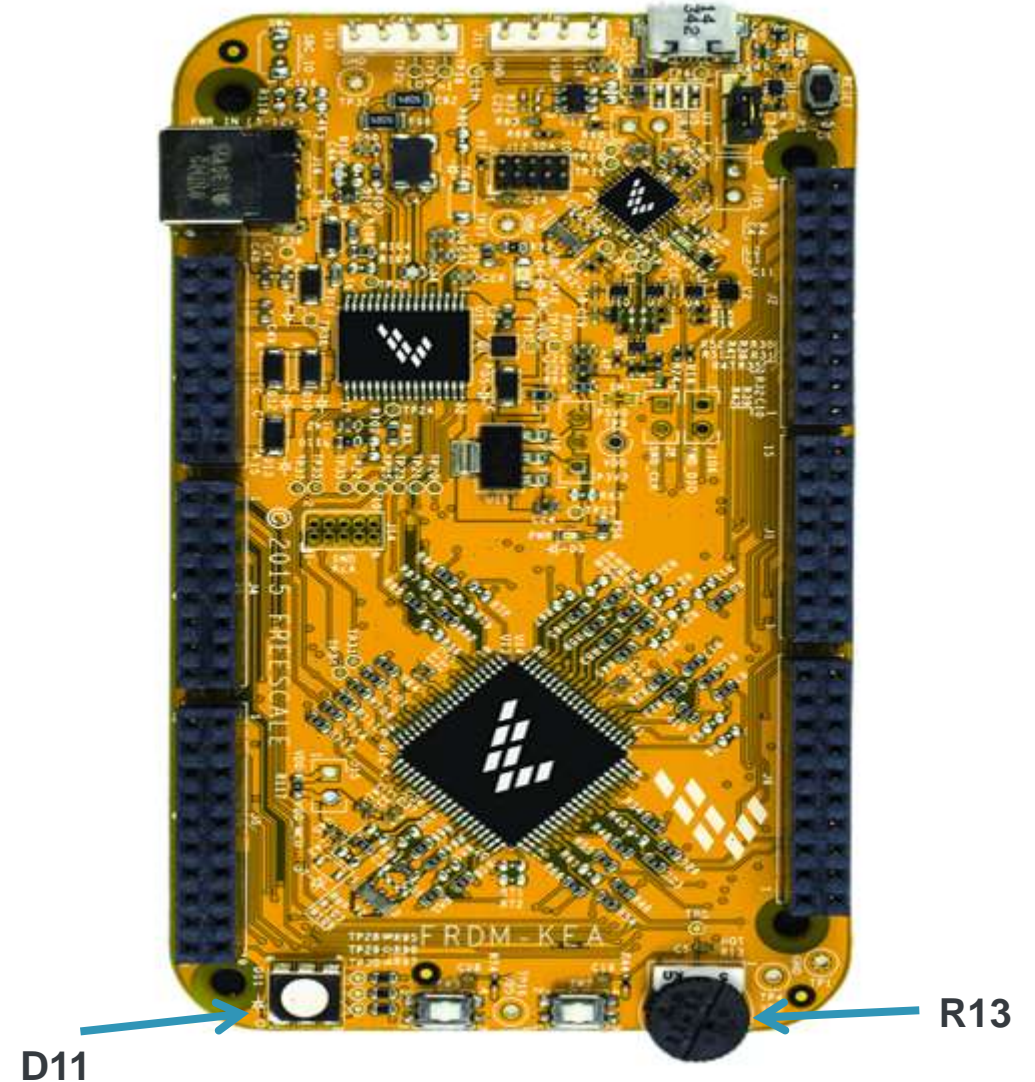



## Step 3: Running Code Example #2 (Dimming LED Demo)

**Code Example #2** modulates the brightness of LED as you turn the potentiometer

- Press SW2
- All three LEDs within D11 will turn on
- This will combine to produce white light
- The Dimming LED Demo uses RTC and ADC to modulate LD brightness
- RTC interrupt functions as a PWM and ADC value determines duty-cycle. A long duty-cycle, means LED is on for longer portion of period. Perceived by the human eye as brighter light
- Dial the potentiometer R13 and observe LED change brightness

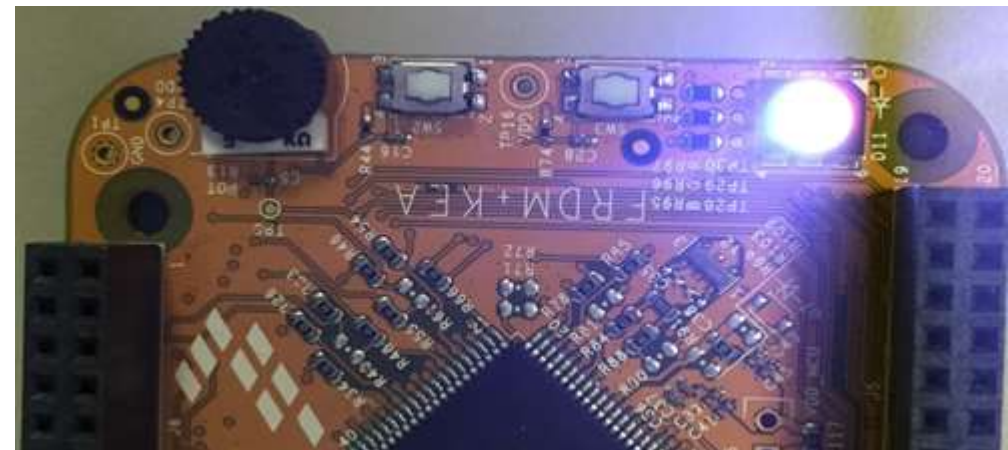
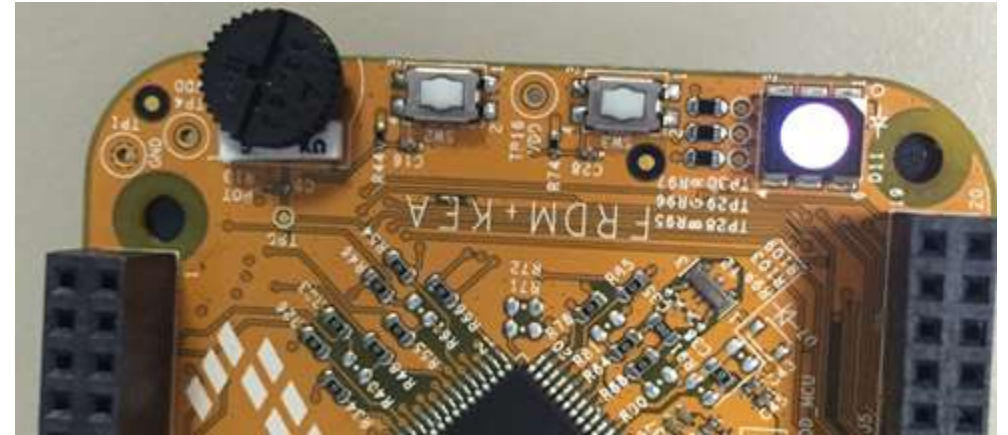



**A step by step KEA SDK driver Integration Guide in S32 Design Studio is available to assist loading drivers and code examples for each into a S32DS project**

- **Peripheral Drivers (SDK)**

- ACMP
- ADC\_FIFO
- ADC\_Interrupt
- ADC\_Polling
- Bitband
- BME
- CRC
- FLASH\_FTMRE
- FTM\_Combine
- FTM\_DualEdge
- FTM\_EPWM
- FTM\_OutputCompare
- GPIO
- I2C\_MasterInt
- I2C\_MasterPoll
- I2C\_Slave

- **Continued...**

- ICS\_FEE
- ICS\_FEI
- WDOG
- KBI
- PIT
- PMC
- PWT
- RTC
- SPI\_MasterInt
- SPI\_MasterPoll
- SPI\_Slave
- UART\_Interrupt
- UART\_Loopback
- UART\_Polling
- WDOG

# Documentation and Reference Material

## Documentation Links

- FRDM Factsheet
- [KEA128 Sub-Family Datasheet](#)
- [KEA64 / KEAN32 Sub-Family Datasheet](#)
- How to Install S32 Design Studio for ARM MCUs
- SDK Drivers for KEAZ128, KEAZ64 and KEAZN32

## Application Notes

- KEA Application Cookbook
- [KEA Family Appnote](#)
- [DC Motor Control using PWT](#)
- [Migrating from 8-bit to KEA](#)

## Reference Manuals

- [KEA128 Sub-Family Reference Manual](#)
- [KEA64 /KEAN32 Sub-Family Reference Manual](#)

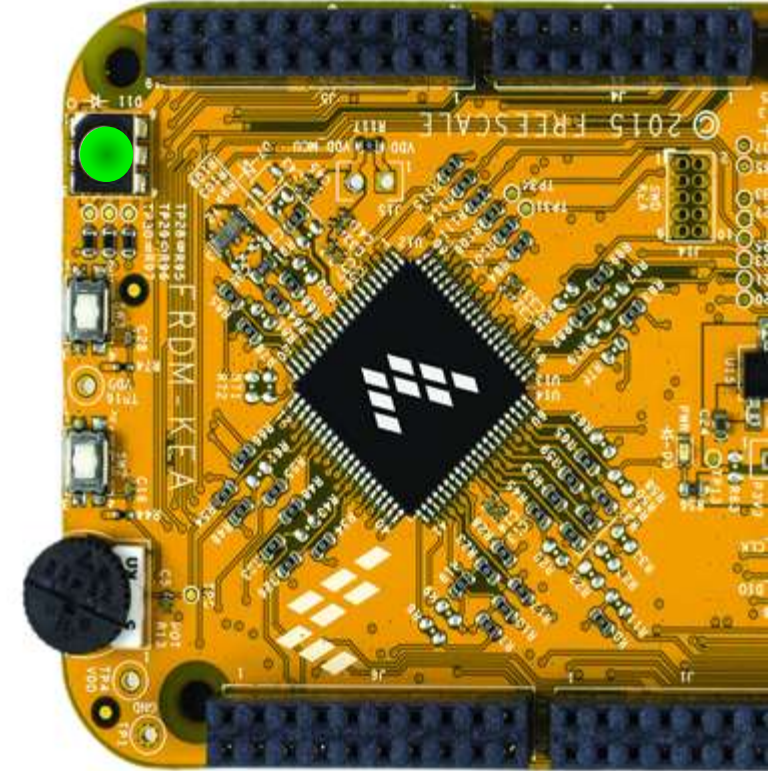

# Development Tools Ecosystem

## IDE / Compilers & Debuggers

- Free S32 Design Studio IDE
  - Processor Expert coming in 2016
- Free KDS IDE support w/ Processor Expert support
- CodeWarrior 10.6 IDE w/ Processor Expert support
- Keil w/ CMSIS compliant drivers
- IAR
- Cosmic IDE for Kinetis ARM based MCUs

## Programmers

- OpenSDA
- P&E MultiLink

## Support Tools:

- FREEMASTER run time debug monitor and instrumentation/calibration tool
- MCAT – Motor Control Application Tool
- Automotive math and motor control library for Cortex® M0+ based products

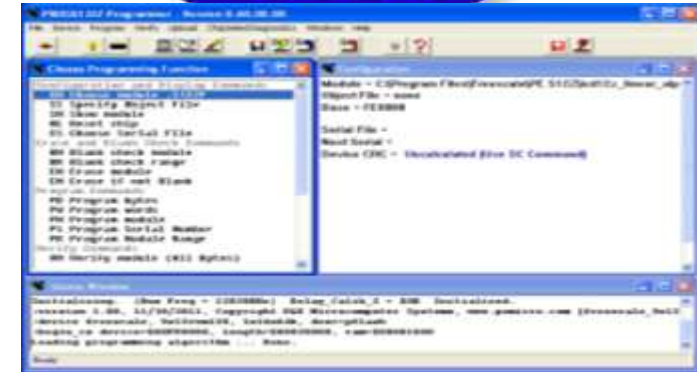



# Kinetis KEA Family – Feature Set Comparison

MCU	FEATURES													
	Flash	RAM	EE PROM	FREQ	MS-CAN	SCI	SPI	ATD	PWT	Flex-Tim	ACMP	IIC	GPIO	Packages
<b>KEAZ128</b>	128K	16K	emulate	48MHz	1	3	2	16c12b	1	6c+2c+2c 16b	2	2	Up to 71	64/80 LQFP
<b>KEAZ64</b>	64K	8K	emulate	48MHz	1	3	2	16c12b	1	6c+2c+2c 16b	2	2	Up to 71	64/80 LQFP
KEAZN64	64K	4K	256B	40MHz	0	3	2	16c12b	NA	6c+2c+2c 16b	2	2	Up to 57	32/64 LQFP
<b>KEAZN32</b>	32K	4K	256B	40MHz	0	3	2	16c12b	NA	6c+2c+2c 16b	2	2	Up to 57	32/64 LQFP
KEAZN16	16K	2K	256B	40MHz	0	3	2	16c12b	NA	6c+2c+2c 16b	2	2	Up to 57	32/64 LQFP
KEAZN8	8K	1K	emulate	48MHz	0	1	1	12c12b	1	6c+2c 16b	2	1	Up to 22	16 TSSOP/ 24 QFN

 Available Freescale Freedom development kit

# Ordering Information

Hardware	Type	Part Number	Package	Pricing
Evaluation (EVB)	Freescale Freedom Board	FRDM-KEAZ128Q80	80 LQFP	\$29
Evaluation (EVB)	Freescale Freedom Board	FRDM-KEAZ64Q80	64 LQFP	\$29
Evaluation (EVB)	Freescale Freedom Board	FRDM-KEAZN32Q64	64 LQFP	\$29



OpenSDA is an open-standard serial and debug adapter. It bridges serial and debug communications between a USB host and an embedded target processor. OpenSDA software includes a flash-resident USB mass-storage device (MSD) bootloader and a collection of OpenSDA Applications. FRDM-KL26Z comes with the MSD Flash Programmer OpenSDA Application preinstalled. Follow these instructions to run the OpenSDA Bootloader and update or change the installed OpenSDA Application.

## Enter OpenSDA Bootloader Mode

1. Unplug the USB cable if attached
2. Press and hold the Reset button (SW2)
3. Plug in a USB cable (not included) between a USB host and the OpenSDA USB connector (labeled “SDA”)
4. Release the Reset button

A removable drive should now be visible in the host file system with a volume label of **BOOTLOADER**. You are now in OpenSDA Bootloader mode.

**IMPORTANT NOTE:** Follow the “Load an OpenSDA Application” instructions to update the MSD Flash Programmer on your FRDM-KL26Z to the latest version. It is likely that the version provided in this package is newer than what was preprogrammed on your FRDM-KL26Z.

## Load an OpenSDA Application

1. While in OpenSDA Bootloader mode, double-click **SDA\_INFO.HTML** in the **BOOTLOADER** drive. A web browser will open the OpenSDA homepage containing the name and version of the installed Application. This information can also be read as text directly from **SDA\_INFO.HTML**
2. Locate the **OpenSDA Applications** folder in the FRDM-KEA Quick Start Package
3. Copy & paste or drag & drop the MSD Flash Programmer Application to the **BOOTLOADER** drive
4. Unplug the USB cable and plug it in again. The new OpenSDA Application should now be running and a **FRDM-KEA** drive should be visible in the host file system

You are now running the latest version of the MSD Flash Programmer. Use this same procedure to load other OpenSDA Applications.



The MSD Flash Programmer is a composite USB application that provides a virtual serial port and an easy and convenient way to program applications into the KEA MCU. It emulates a FAT16 file system, appearing as a removable drive in the host file system with a volume label of FRDM-KEA. Raw binary and Motorola S-record files that are copied to the drive are programmed directly into the flash of the KEA and executed automatically. The virtual serial port enumerates as a standard serial port device that can be opened with standard serial terminal applications.

## Using the MSD Flash Programmer

1. Locate the Precompiled Examples folder in the FRDM-KEAZ128 Quick Start Package
2. Copy & paste or drag & drop one of the .srec files to the FRDM-KEA drive

The new application should now be running on the FRDM-KEA. Starting with v1.03 of the MSD Flash Programmer, you can program repeatedly without the need to unplug and reattach the USB cable before reprogramming.

Drag one of the .srec code examples from the KEA code example folder onto the FRDM-KEA board over USB to reprogram the preloaded code example to another example.

**NOTE:** Flash programming with the MSD Flash Programmer is currently only supported on Windows operating systems. However, the virtual serial port has been successfully tested on Windows, Linux and Mac operating systems.

## Using the Virtual Serial Port

1. Determine the symbolic name assigned to the FRDM-KEAZ128 virtual serial port. In Windows open Device Manager and look for the COM port named “PEMicro/Freescale – CDC Serial Port”.
2. Open the serial terminal emulation program of your choice. Examples for Windows include [Tera Term](#), [PuTTY](#), and [HyperTerminal](#)
3. Program one of the “code example programs” from the Code Examples folder using the MSD Flash Programmer.
4. Configure the terminal program. Most embedded examples use 8 data bits, no parity bits, and one stop bit (8-N-1). Match the baud rate to the selected serial test application and open the port.
5. Press and release the Reset button (SW0) at anytime to restart the example application. Resetting the embedded application will not affect the connection of the virtual serial port to the terminal program.

**NOTE:** Refer to the OpenSDA User’s Guide for a description of a known Windows issue when disconnecting a virtual serial port while the COM port is in use.



[www.Freescale.com](http://www.Freescale.com)