

SP6669

600 mA 1.5 MHz PWM Synchronous Step Down Converter



Evaluation Board Configuration

Input Voltage	2.5 V - 5.5 V
Output Voltage	1.8 V
Max. Output Current	600 mA
Operating Frequency	1.5 MHz
Inductor Reference	4.7 µH – WE-TPC 744 025 004

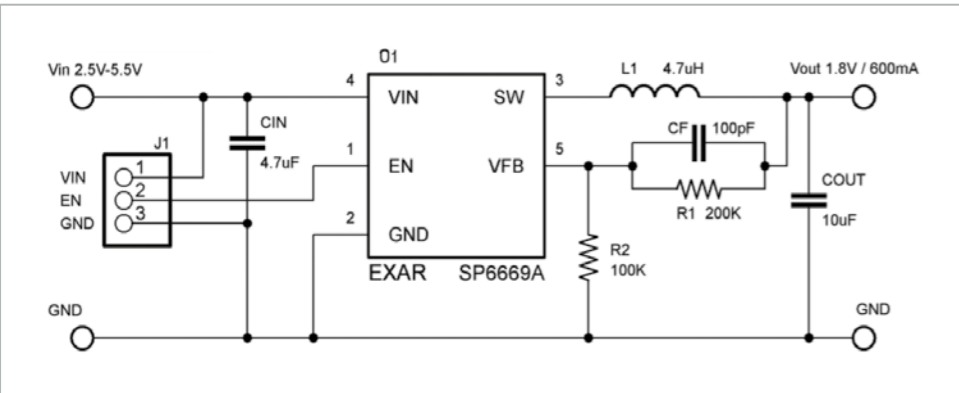

Inductor Value L – Resistor Values R1 / R2 Selector

V _{OUT} / I _{OUT}	V _{IN} = 3.3 V			V _{IN} = 5.0 V			R1	R2
	100 mA	300 mA	600 mA	100 mA	300 mA	600 mA		
3.3 V				22 µH 744 025 220	6.8 µH 744 025 006	4.7 µH 744 025 004	453 kΩ	100 kΩ
2.8 V	10 µH 744 032 910 0	3.3 µH 744 025 003	1.5 µH	22 µH 744 025 220	6.8 µH 744 025 006	4.7 µH 744 025 004	365 kΩ	100 kΩ
2.5 V	15 µH 744 025 150	4.7 µH 744 032 900 4	2.2 µH 744 032 900 2	22 µH 744 025 220	6.8 µH 744 025 006	4.7 µH 744 025 004	316 kΩ	100 kΩ
1.8 V	15 µH 744 025 150	4.7 µH 744 032 900 4	3.3 µH 744 025 003	22 µH 744 025 220	6.8 µH 744 025 006	4.7 µH 744 025 004	200 kΩ	100 kΩ
1.2 V	15 µH 744 025 150	4.7 µH 744 032 900 4	3.3 µH 744 025 003	18 µH 744 032 180	6.8 µH 744 025 006	3.3 µH 744 025 003	100 kΩ	100 kΩ
0.8 V	15 µH 744 025 150	4.7 µH 744 032 900 4	2.2 µH 744 032 900 2	15 µH 744 032 001 5	4.7 µH 744 025 004	2.2 µH 744 025 002	33 kΩ	100 kΩ

Best suitable inductor

Lowest profile inductor

Evaluation board configuration

Design Tips

Output Voltage Selection

The output voltage is adjustable via the external resistor network R1 and R2 as per the following formula:

$$V_{OUT} = V_{REF} \cdot \left(1 + \frac{R1}{R2}\right)$$

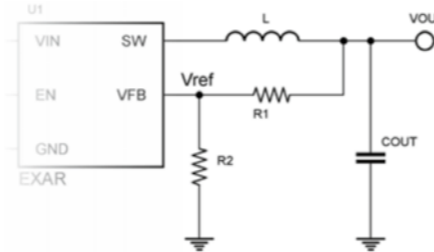

Where

V_{REF} = Reference voltage at 0.6 V

The feedback resistors must be chosen such that power dissipation of the network is minimal. R1 and R2 are typically allowed within a given range; adhere to the recommended values in the tables.

Inductor Selection

Inductor ripple current and saturation current ratings are two factors to be considered when selecting the inductor value.

A low R_{DC} inductor is preferred. The inductor value L can be calculated from the following equation:

$$L = (V_{IN} - V_{OUT}) \cdot \left(\frac{V_{OUT}}{V_{IN}}\right) \cdot \left(\frac{1}{f}\right) \cdot \left(\frac{1}{\Delta I_L}\right)$$

Where

L = Inductor value

V_{IN} = Input voltage

V_{OUT} = Output voltage

f = Operating frequency

ΔI_L = Current ripple – usually set between 30% and 40% of output current desired

The inductor value for the evaluation boards is set for an output current ripple of approximately 30% to 40% of the maximum output current desired. An output current ripple level of 30% to 40% is acceptable in most designs and may provide extra flexibility in selecting the appropriate inductor value.

Note

All product documentations, including datasheets, evaluation board manuals and bill of material can be found on

www.exar.com/wurth_electronics

www.we-online.com/exar

up to 97 % efficiency

DESIGN KIT Low Power – Point of Load Solutions



600 mA to 1.5 A,
Low Input Voltage
Single and Dual
Channel Converter

Order Code IC-744 721
Version 1.0

Exar Device	Max. Output Current	Input Voltage Range	Output Voltage Range	Operating Frequency	Max Efficiency	Package	Würth Elektronik Inductor	
							Value	Reference
SP6669	0.6 A	2.5 V - 5.5 V	0.6 V - V _{IN}	1.5 MHz	95 %	SOT23-5	4.7 µH	744 025 004
XRP6658	1 A	2.5 V - 5.5 V	0.6 V - V _{IN}	1.5 MHz	97 %	SOT23-5	2.2 µH	744 043 002 2
XRP6668	1A / 1A	2.5 V - 5.5 V	0.6 V - V _{IN}	1.5 MHz	97 % / 97 %	SOIC8	2.2 µH / 2.2 µH	744 043 002 2
XRP6657	1.5 A	2.5 V - 5.5 V	0.6 V - V _{IN}	1.5 MHz	95 %	DFN6	1.8 µH	744 773 018

XRP6658

1 A 1.5 MHz Synchronous Step Down Converter

More information on www.we-online.com/exar

Evaluation Board Configuration

Input Voltage	2.5 V - 5.5 V
Output Voltage	3.3 V
Max. Output Current	1 A
Operating Frequency	1.5 MHz
Inductor Reference	2.2 μ H – WE-TPC 744 043 002 2

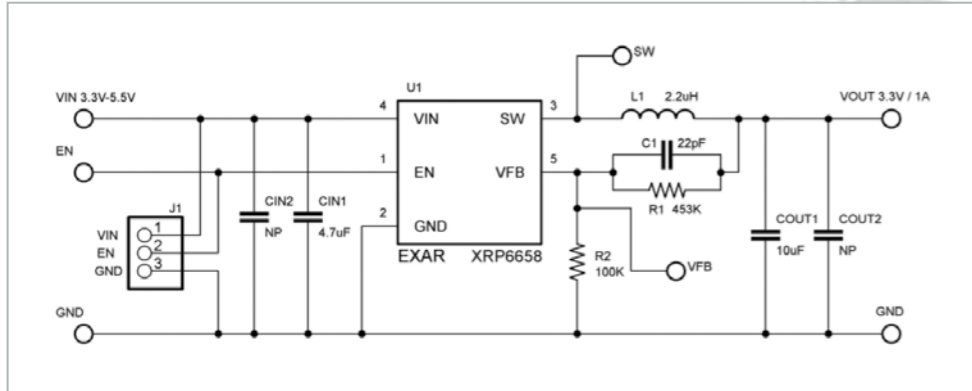

Inductor Value L – Resistor Values R1 / R2 Selector

V_{out}/I_{out}	$V_{in} = 3.3 V$			$V_{in} = 5.0 V$			R1	R2
	100 mA	500 mA	1000 mA	100 mA	500 mA	1000 mA		
3.3 V				22 μ H	4.7 μ H	2.2 μ H	453 k Ω	100 k Ω
2.8 V	10 μ H	1.8 μ H	1.0 μ H	22 μ H	4.7 μ H	2.2 μ H	365 k Ω	100 k Ω
2.5 V	15 μ H	2.2 μ H	1.2 μ H	22 μ H	4.7 μ H	2.2 μ H	316 k Ω	100 k Ω
1.8 V	15 μ H	3.3 μ H	1.5 μ H	22 μ H	6.8 μ H	2.2 μ H	200 k Ω	100 k Ω
1.2 V	15 μ H	3.3 μ H	1.5 μ H	18 μ H	3.3 μ H	1.8 μ H	100 k Ω	100 k Ω
0.8 V	15 μ H	2.2 μ H	1.2 μ H	15 μ H	3.3 μ H	1.5 μ H	33 k Ω	100 k Ω

Best suitable inductor Lowest profile inductor Evaluation board configuration

XRP6668

1 A/1 A Dual Channel 1.5 MHz Synchronous Step Down Converter

Evaluation Board Configuration

Input Voltage	2.5 V - 5.5 V
Output Voltage	3.3V/1.8 V
Max. Output Current	1 A/1 A
Operating Frequency	1.5 MHz
Inductor Reference	2.2 μ H – WE-TPC 744 043 002 2

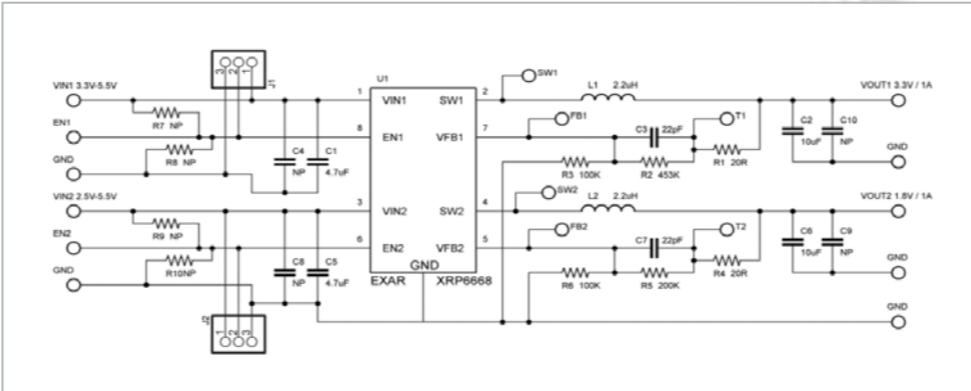

Inductor Value L – Resistor Values R1 / R2 Selector

V_{out}/I_{out}	$V_{in} = 3.3 V$			$V_{in} = 5.0 V$			R1	R2
	100 mA	500 mA	1000 mA	100 mA	500 mA	1000 mA		
3.3 V				22 μ H	4.7 μ H	2.2 μ H	453 k Ω	100 k Ω
2.8 V	10 μ H	1.8 μ H	1.0 μ H	22 μ H	4.7 μ H	2.2 μ H	365 k Ω	100 k Ω
2.5 V	15 μ H	2.2 μ H	1.2 μ H	22 μ H	4.7 μ H	2.2 μ H	316 k Ω	100 k Ω
1.8 V	15 μ H	3.3 μ H	1.5 μ H	22 μ H	6.8 μ H	2.2 μ H	200 k Ω	100 k Ω
1.2 V	15 μ H	3.3 μ H	1.5 μ H	18 μ H	3.3 μ H	1.8 μ H	100 k Ω	100 k Ω
0.8 V	15 μ H	2.2 μ H	1.2 μ H	15 μ H	3.3 μ H	1.5 μ H	33 k Ω	100 k Ω

Best suitable inductor Lowest profile inductor Evaluation board configuration

Note: The above table values apply to each channel of the XRP6668.

XRP6657

1.5 A 1.3 MHz Synchronous Step Down Converter



Evaluation Board Configuration

Input Voltage	2.5 V - 5.5 V
Output Voltage	1.8 V
Max. Output Current	1.5 A
Operating Frequency	1.3 MHz
Inductor Reference	1.8 μ H – WE-PD2 744 773 018

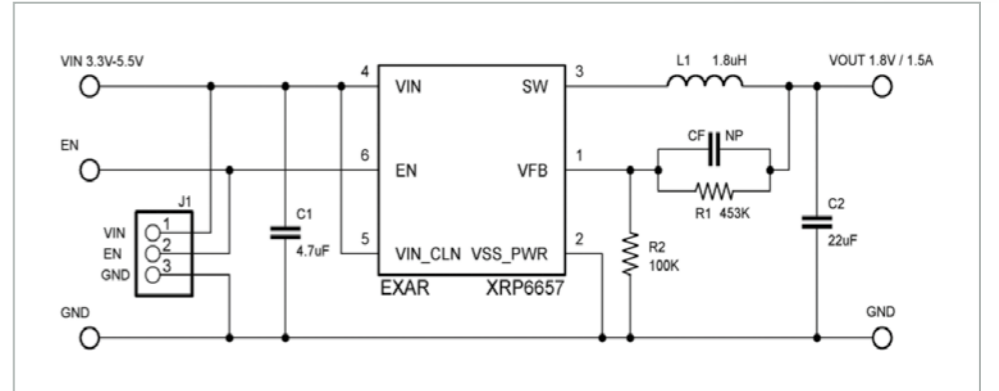

Inductor Value L – Resistor Values R1 / R2 Selector

V_{out}/I_{out}	$V_{in} = 3.3 V$			$V_{in} = 5.0 V$			R1	R2
	100 mA	750 mA	1500 mA	100 mA	750 mA	1500 mA		
3.3 V				33 μ H	3.3 μ H	1.8 μ H	453 k Ω	100 k Ω
2.8 V	10 μ H	1.5 μ H	1.0 μ H	33 μ H	3.3 μ H	1.8 μ H	365 k Ω	100 k Ω
2.5 V	15 μ H	1.8 μ H	1.0 μ H	33 μ H	3.3 μ H	1.8 μ H	316 k Ω	100 k Ω
1.8 V	18 μ H	2.2 μ H	1.5 μ H	33 μ H	3.3 μ H	1.8 μ H	200 k Ω	100 k Ω
1.2 V	18 μ H	2.2 μ H	1.0 μ H	22 μ H	3.3 μ H	1.5 μ H	100 k Ω	100 k Ω
0.8 V	15 μ H	1.8 μ H	1.0 μ H	15 μ H	2.2 μ H	1.0 μ H	33 k Ω	100 k Ω

Best suitable inductor Lowest profile inductor Evaluation board configuration