

## 1. Introduction

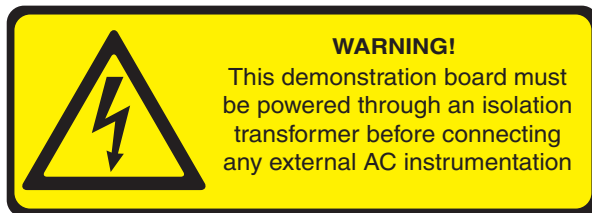

IXYS Integrated Circuits Division's IX9908 Evaluation Board contains all the necessary circuitry to demonstrate the features of the IX9908 single-stage flyback controller in a triac dimmable, high power factor LED driver. The IX9908 IC architecture includes quasi-resonant primary control with an integrated high voltage startup cell. This evaluation board features high power factor, high efficiency and outstanding dimming performance.

### 1.1 Features:

- TRIAC dimmer compatible, no output flicker or pop-on
- Fast startup
- High efficiency >85%
- Low cost, low component count
- Open string protection
- High power factor > 0.9
- Digital soft-start
- Cycle-by-cycle peak current control

Figure 1. IX9908 Evaluation Board, Top View



## 2. Power Supply Specifications

Parameter	Symbol	Range	Units
Input Voltage	$V_{IN}$	90-135	$V_{AC}$
Input Frequency	f-line	60	Hz
Output Voltage	$V_{out}$	19-26	V
Output Current	$I_{out}$	450-600	mA
Efficiency	-	85-86	%
Power Factor	-	0.92 min	-

Figure 2. IX9908 Evaluation Board Schematic

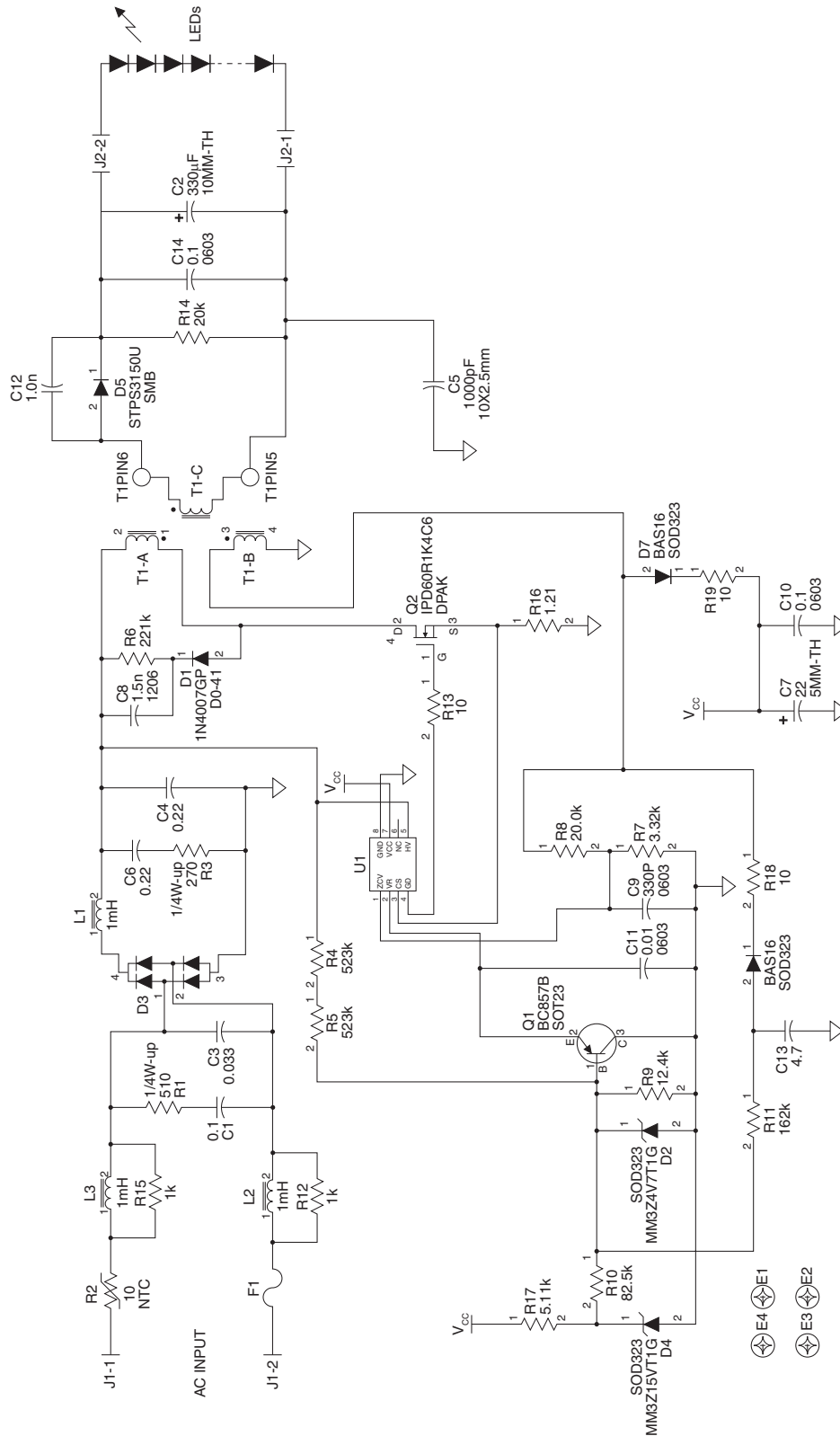

### 3. Circuit Description

The IX9908 is configured to drive an external MOSFET in a quasi-resonant flyback converter power stage providing a constant current output to a LED string while maintaining high power factor.

#### 3.1 Input Filtering:

Fuse F1 provides input overcurrent protection. Diode bridge D3 rectifies the AC line and C4 provides decoupling for the input to the buck converter. L1, L2, L3, C3 and C4 form a 2 stage conducted EMI filter. R12 and R15 provide damping for any resonances between the input inductors, capacitors and the AC line impedance.

Damping networks R1-C1 and R3-C6 provide damping of the filter when the circuit is connected to a TRIAC based dimmer. Otherwise the high dv/dt when the TRIAC turns on would create large oscillations in the line current that would commutate the TRIAC before the next zero crossing of the AC line cycle.

#### 3.2 Power Stage:

Q2, T1, D5 and C2 form a flyback converter power stage. The IX9908 drives the gate of MOSFET Q2. Current is sensed with R16 and the signal fed back into the IX9908. The IX9908 provide leading edge blanking of the current signal, eliminating the need for an external R-C filter.

The AC input voltage is sensed through R4, R5 and R9 and applied to the base of transistor Q1, the emitter of which is connected to the VR pin of the IX9908. The peak current in the primary winding is approximately proportional to the voltage on the VR pin of the IX9908. This causes the input line current to be shaped in a sinusoidal fashion and therefore high power factor is achieved.

Line regulation is achieved by the circuitry formed by R18, D6, C13 and R11, as well as the internal foldback correction function of the IX9908. D6 and C13 rectify the bias winding of transformer T1 to produce a negative voltage proportional to the rectified input voltage. This negative voltage is summed into the voltage on the base of Q1 through R11. This stabilizes the voltage at the VR against variations in line voltage. In order to prevent the voltage on VR from going too low, R10, R17 and D4 add a DC offset to the base of Q1.

The internal foldback correction circuit senses the input voltage through R8 and the bias winding of the transformer T1. This means that the primary winding current will decrease as the input voltage increases. The amount of the reduction in primary current is adjusted by varying R8.

#### 3.3 Performance Data

Number of LEDs in Output String	LED String Current	LED String Voltage	LED String Power	Input Power Factor	Efficiency
6	0.568	19.34	11.0	0.948	85.3
7	0.528	22.385	11.8	0.953	85.7
8	0.49	25.35	12.42	0.957	85.9

#### 4. Evaluation Board Bill of Materials

Ref. Des.	Qty.	Description	Manufacturer	Mfr. P/N
C11	1	CAP CER 10000PF 50V 10% X7R 0603	KEMET	C0603C103K5RACTU
C10, C14	2	CAP CER 0.1UF 50V 10% X7R 0603	YAGEO	CC0603KRX7R9BB104
C9	1	CAP CER 330PF 50V 10% X7R 0603	YAGEO	CC0603KRX7R9BB331
C12	1	CAP CER 1000PF 200V 10% X7R 0805	YAGEO	CC0805KRX7RABB102
C13	1	CAP CER 4.7UF 10V 10% X7R 0805	TAIYO YUDEN	LMK212B7475KG-T
C8	1	CAP CER 1500PF 500V 10% X7R 1206	SAMSUNG ELECTRO-MECHANICS AMERICA, INC	CL31B152KGFNNNE
C7	1	CAP ALUM 22UF 25V 20% RADIAL	NICHICON	UPW1E220MDD6
C2	1	CAP ALUM 330UF 35V 20% RADIAL	PANASONIC ELECTRONIC COMPONENTS	EEU-FM1V331
C1	1	CAP FILM 0.1UF 250VDC RADIAL	PANASONIC ELECTRONIC COMPONENTS	ECQ-E2104KB
C4, C6	2	CAP FILM 0.22UF 250VDC RADIAL	PANASONIC ELECTRONIC COMPONENTS	ECQ-E2224JB
C3	1	CAP FILM 0.033UF 630VDC RADIAL	VISHAY BC COMPONENTS	BFC233920333
C5	1	CAP CER 1000PF 500VAC 20% RADIAL	VISHAY BC COMPONENTS	VY1102M35Y5UQ63V0
J1, J2	2	CONN TERMINAL BLOCK 2POS 5.08MM	MOLEX CONNECTOR CORPORATION	39544-3002
D3	1	RECT BRIDGE GPP 600V 0.8A MBS	COMCHIP TECHNOLOGY	B6S-G
D6, D7	2	DIODE SWITCHING 75V 0.2A SOD323	ON SEMICONDUCTOR	BAS16HT1G
D5	1	DIODE SCHOTTKY 150V 3A SMB	STMICROELECTRONICS	STPS3150U
D1	1	DIODE GEN PURPOSE 1000V 1A DO41	MICRO COMMERCIAL CO	1N4007GP-TP
D4	1	DIODE ZENER 15V 200MW SOD323	ON SEMICONDUCTOR	MM3Z15VT1G
D2	1	DIODE ZENER 4.7V 200MW SOD323	ON SEMICONDUCTOR	MM3Z4V7T1G
F1	1	FUSE SLOW 250VAC 1.25A RADIAL	BEL FUSE INC	RST 1.25
E1, E2, E3, E4	4	STANDOFF HEX 1.00"L 4-40THR NYL	KEYSTONE ELECTRONICS	1902E
L1, L2, L3	3	INDUCTOR 1000UH .15A RADIAL	RENCO ELECTRONICS	RL-5480-2-1000
Q2	1	MOSFET N-CH 600V 3.2A TO252-3	INFINEON TECHNOLOGIES	IPD60R1K4C6
R2	1	CURRENT LIMITER INRSH 10 OHM RAD	EPCOS INC	B57153S0100M000
R13, R18, R19	3	RES 10.0 OHM 1/10W 1% 0603 SMD	YAGEO	RC0603FR-0710RL
R9	1	RES 12.4K OHM 1/10W 1% 0603	STACKPOLE ELECTRONICS INC	RMCF0603FT12K4
R11	1	RES 162K OHM 1/10W 1% 0603 SMD	PANASONIC ELECTRONIC COMPONENTS	ERJ-3EKF1623V
R8	1	RES 20K OHM 1/10W 1% 0603 SMD	PANASONIC ELECTRONIC COMPONENTS	ERJ-3EKF2002V
R7	1	RES 3.32K OHM 1/10W 1% 0603 SMD	PANASONIC ELECTRONIC COMPONENTS	ERJ-3EKF3321V
R4, R5	2	RES 523K OHM 1/10W 1% 0603 SMD	YAGEO	RC0603FR-07523KL
R10	1	RES 82.5K OHM 1/10W 1% 0603 SMD	PANASONIC ELECTRONIC COMPONENTS	ERJ-3EKF8252V
R16	1	RES 1.21 OHM 1/8W 1% 0805	STACKPOLE ELECTRONICS INC	RMCF0805FT1R21
R17	1	RES 5.11K OHM 1/8W 1% 0805 SMD	PANASONIC ELECTRONIC COMPONENTS	ERJ-6ENF5111V
R12, R15	2	RES 1K OHM 1/4W 1% 1206 SMD	PANASONIC ELECTRONIC COMPONENTS	ERJ-8ENF1001V
R14	1	RES 20K OHM 1/4W 1% 1206 SMD	PANASONIC ELECTRONIC COMPONENTS	ERJ-8ENF2002V
R6	1	RES 221K OHM 1/4W 1% 1206 SMD	VISHAY DALE	CRCW1206221KFKEA
R3	1	RES 270 OHM 1W 5% AXIAL	PANASONIC ELECTRONIC COMPONENTS	ERG-1SJ271
R1	1	RES 510 OHM 1W 5% AXIAL	PANASONIC ELECTRONIC COMPONENTS	ERG-1SJ511
Q1	1	TRANSISTOR PNP 45V 100MA SOT323	NXP SEMICONDUCTORS	BC857BW,115
U1	1	IC LED DRIVER SOIC8	IXYS ICD	IX9908N
T1	1	TRANSFORMER	RENCO ELECTRONICS	RLIX-1000

## 5. Operating Waveforms

### 5.1 Output Current with 6 LED string 200mA/DIV

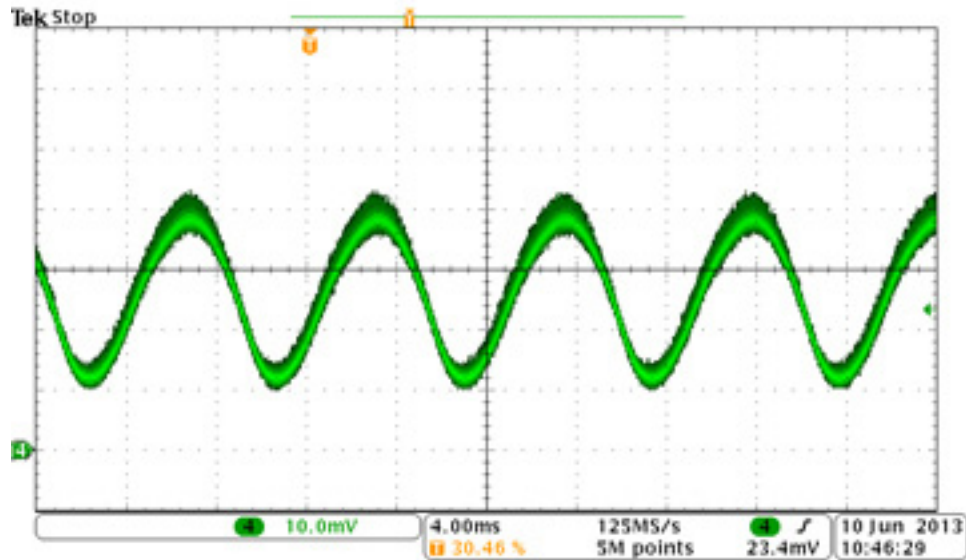

### 5.2 Drain to source voltage - 6 LEDs

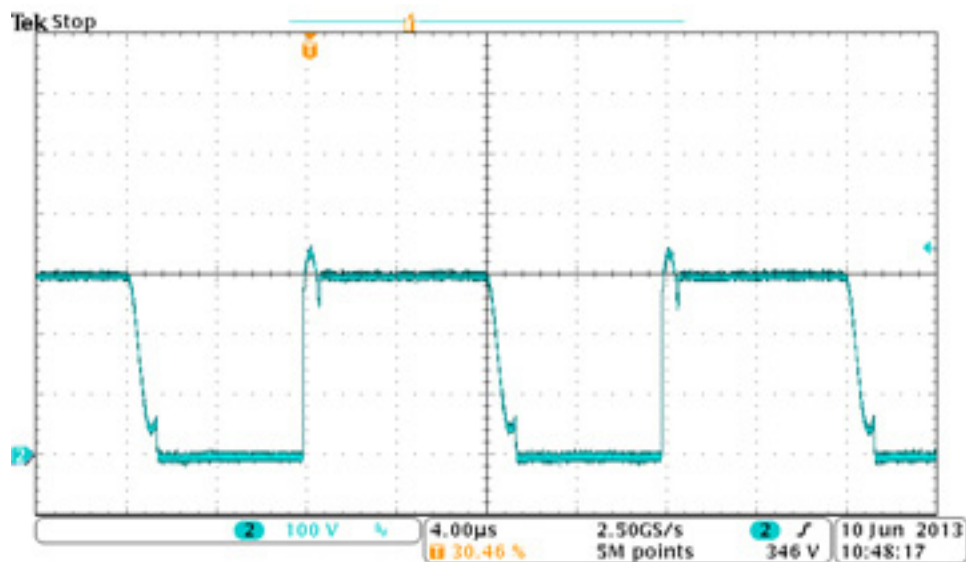

5.3 Output Current with 7 LED string 200mA/DIV

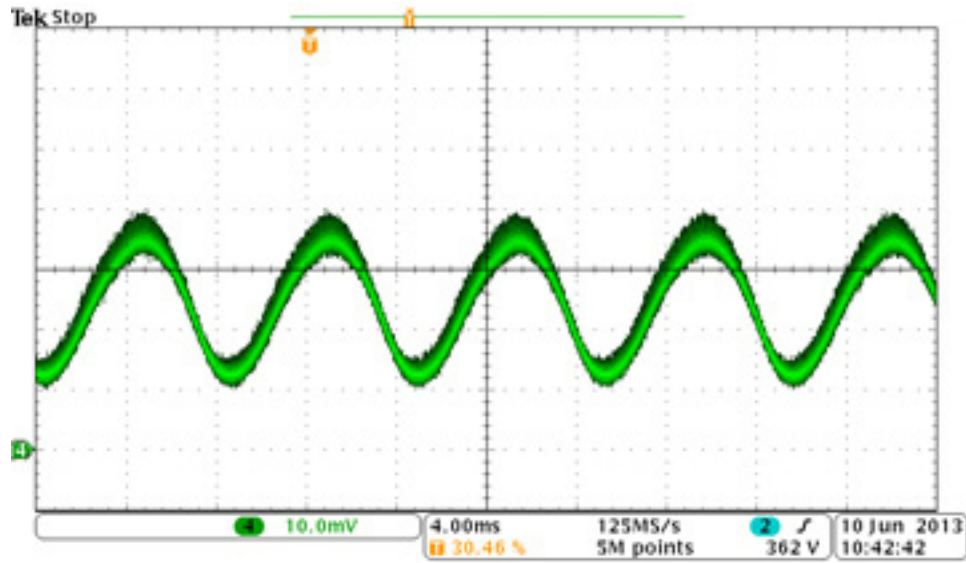

5.4 Drain to source voltage - 7 LEDs

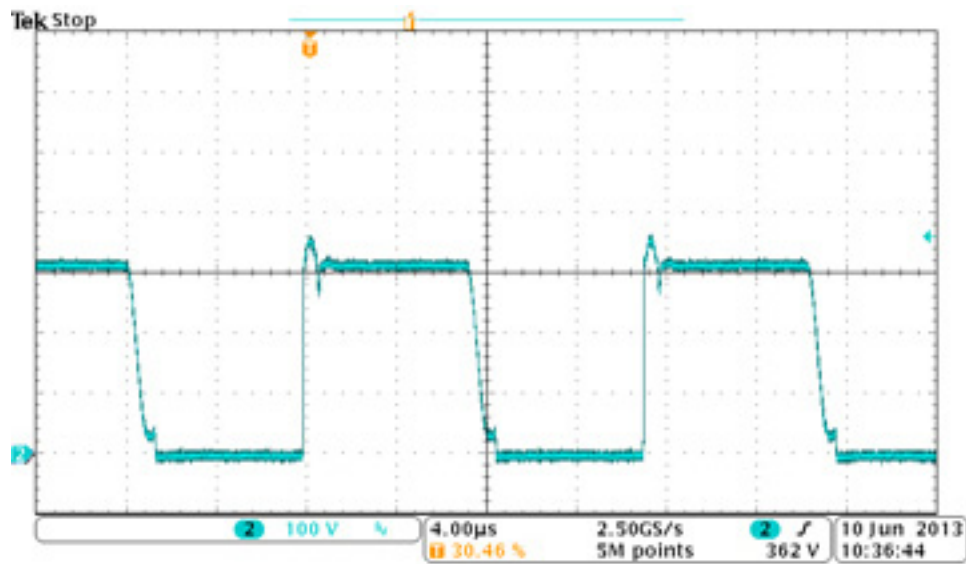

5.5 Output Current with 8 LED string, 200mA/DIV

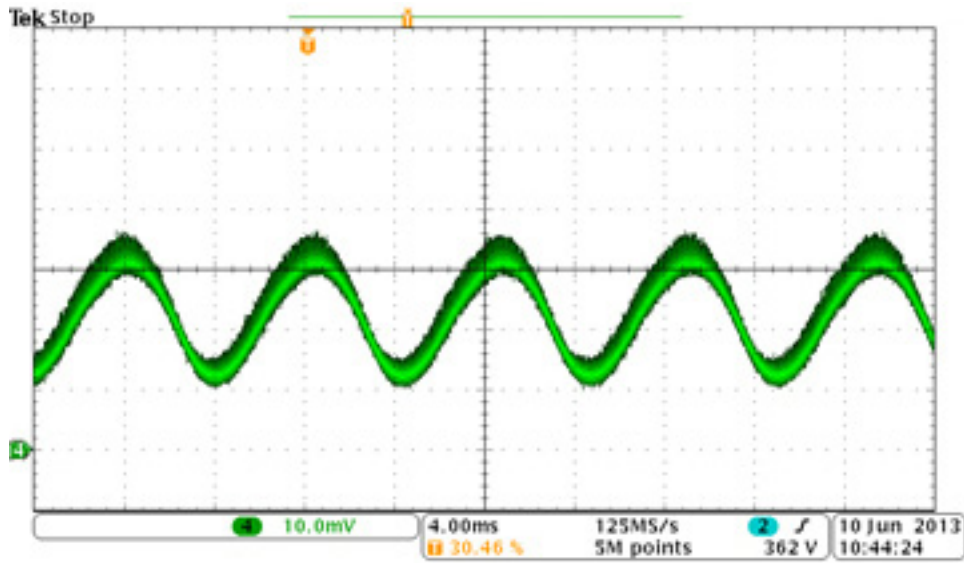

5.6 Drain to source voltage - 8 LEDs

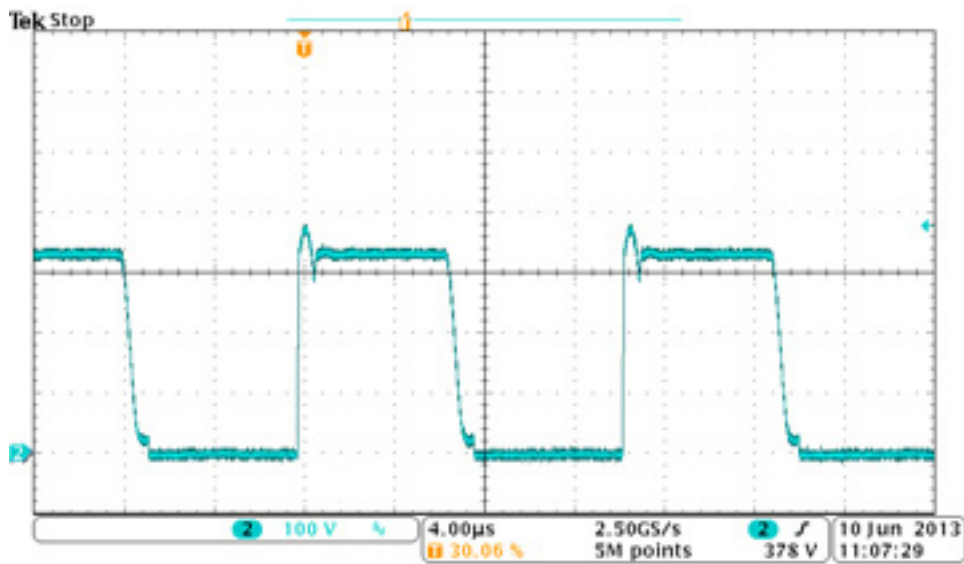

5.7 Dimming Waveforms using 7 LED string

5.7.1 Dimmer full on, upper trace= line voltage, lower trace = LED current 500mA/DIV.

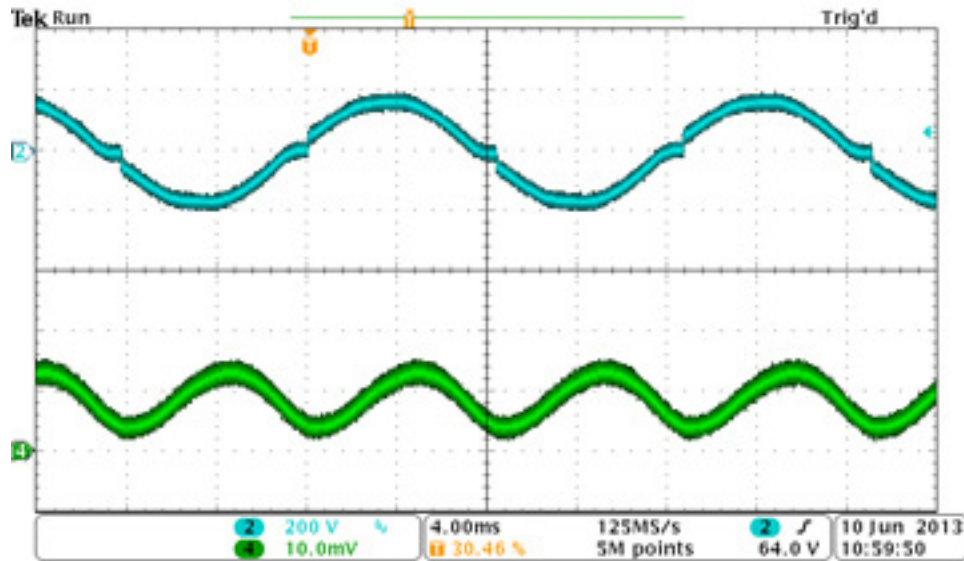

5.7.2 Dimmer on for 6 msec, upper trace= line voltage, lower trace = LED current 500mA/DIV.

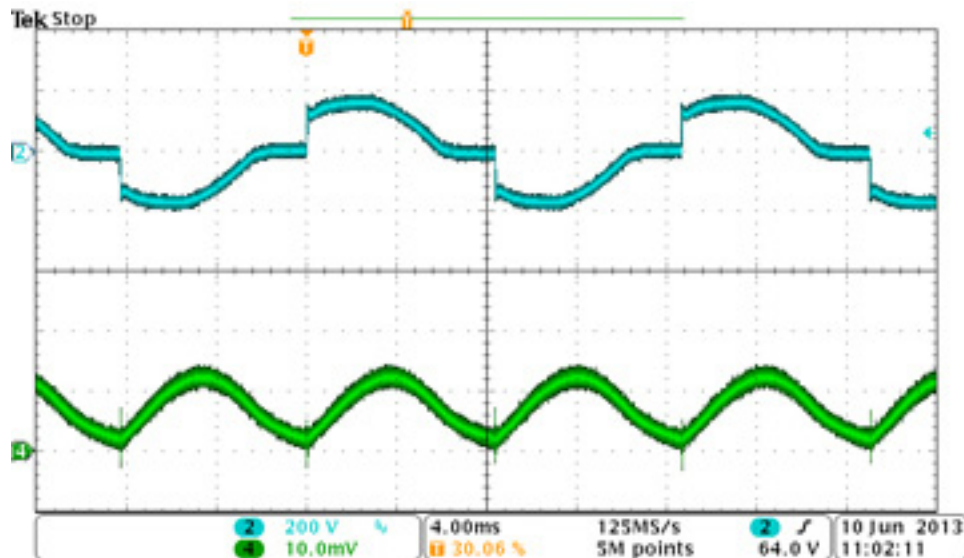



5.7.3 Dimmer on for 4 msec, upper trace= line voltage, lower trace = LED current 500mA/DIV

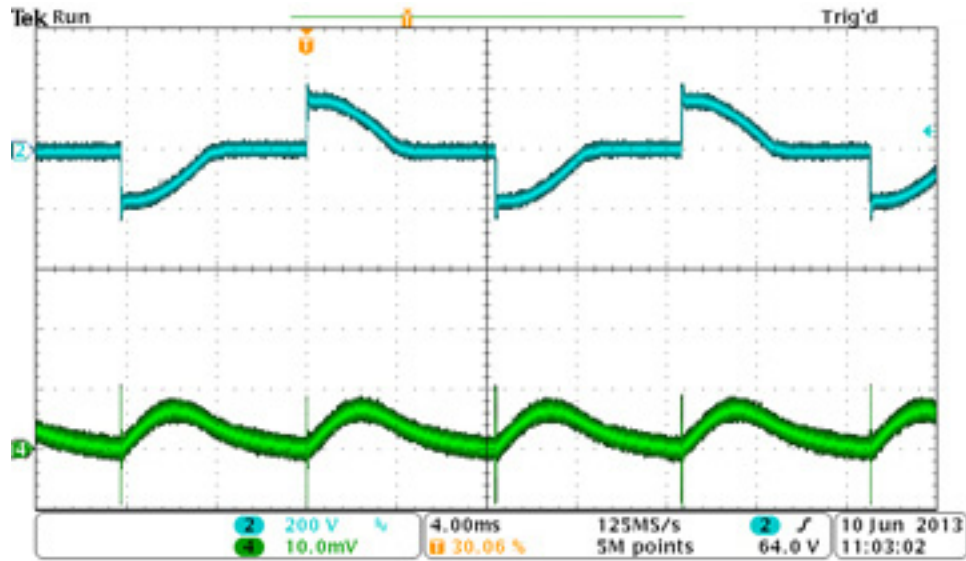

5.7.4 Dimmer on for 2 msec, upper trace= line voltage, lower trace = LED current 500mA/DIV

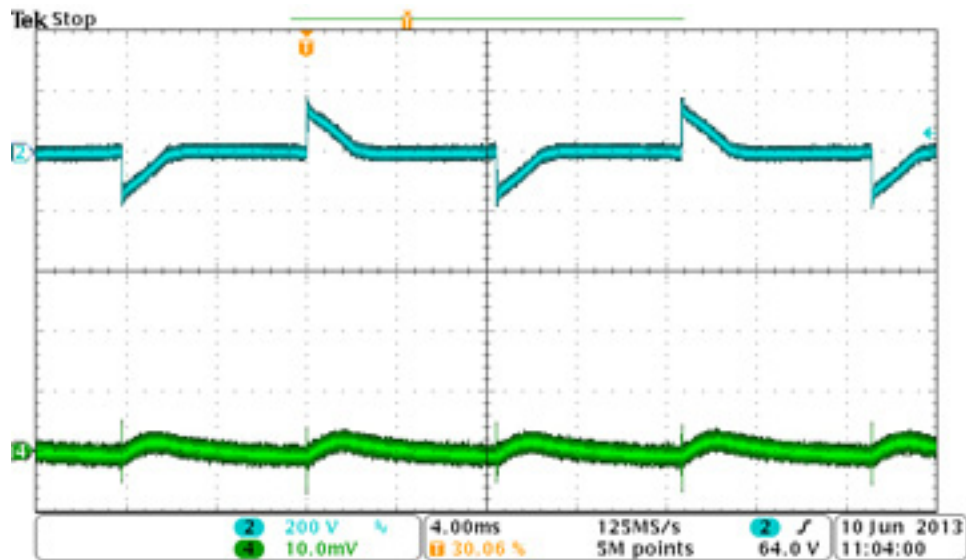

**For additional information please visit [www.ixysic.com](http://www.ixysic.com)**

*IXYS Integrated Circuits Division makes no representations or warranties with respect to the accuracy or completeness of the contents of this publication and reserves the right to make changes to specifications and product descriptions at any time without notice. Neither circuit patent licenses nor indemnity are expressed or implied. Except as set forth in IXYS Integrated Circuits Division's Standard Terms and Conditions of Sale, IXYS Integrated Circuits Division assumes no liability whatsoever, and disclaims any express or implied warranty, relating to its products including, but not limited to, the implied warranty of merchantability, fitness for a particular purpose, or infringement of any intellectual property right.*

*The products described in this document are not designed, intended, authorized or warranted for use as components in systems intended for surgical implant into the body, or in other applications intended to support or sustain life, or where malfunction of IXYS Integrated Circuits Division's product may result in direct physical harm, injury, or death to a person or severe property or environmental damage. IXYS Integrated Circuits Division reserves the right to discontinue or make changes to its products at any time without notice.*

---

Specification: IX9908-UG\_R01  
Copyright © 2013, IXYS Integrated Circuits Division  
All rights reserved. Printed in USA.  
9/17/2013